

SIP CONTEMPORARY SERIES

CTM-S2315

SIP Corded Trimstyle 1-line Hotel Phone

vtech[®]

User's Guide

IMPORTANT SAFETY INSTRUCTIONS

The applied nameplate is located at the bottom or rear of the product.

When using your telephone equipment, basic safety precautions should always be followed to reduce the risk of fire, electric shock and injury, including the following:

1. This product should be installed by a qualified technician.
2. This product should only be connected to the host equipment and never directly to the network such as Public Switch Telephone Network (PSTN) or Plain Old Telephone Services (POTS).
3. Read and understand all instructions.
4. Follow all warnings and instructions marked on the product.
5. Unplug this product from the wall outlet before cleaning. Do not use liquid or aerosol cleaners. Use a damp cloth for cleaning.
6. Do not use this product near water such as near a bath tub, wash bowl, kitchen sink, laundry tub or swimming pool, or in a wet basement or shower.
7. Do not place this product on an unstable table, shelf, stand or other unstable surfaces.
8. Slots and openings in the back or bottom of the telephone base and handset are provided for ventilation. To protect them from overheating, these openings must not be blocked by placing the product on a soft surface such as a bed, sofa or rug. This product should never be placed near or over a radiator or heat register. This product should not be placed in any area where proper ventilation is not provided.
9. This product should be operated only from the type of power source indicated on the marking label. If you are not sure of the type of power supply on the premises, consult your dealer or local power company.
10. Do not allow anything to rest on the power cord. Do not install this product where the cord may be walked on.
11. Never push objects of any kind into this product through the slots in the telephone base or handset because they may touch dangerous voltage points or create a short circuit. Never spill liquid of any kind on the product.
12. To reduce the risk of electric shock, do not disassemble this product, but take it to an authorised service facility. Opening or removing parts of the telephone base or handset other than specified access doors may expose you to dangerous voltages or other risks. Incorrect reassembling can cause electric shock when the product is subsequently used.
13. Do not overload wall outlets and extension cords.
14. Unplug this product from the wall outlet and refer servicing to an authorised service facility under the following conditions:
 - When the power supply cord or plug is damaged or frayed.
 - If liquid has been spilled onto the product.
 - If the product has been exposed to rain or water.

- If the product does not operate normally by following the operating instructions. Adjust only those controls that are covered by the operation instructions. Improper adjustment of other controls may result in damage and often requires extensive work by an authorised technician to restore the product to normal operation.
 - If the product has been dropped and the telephone base and/or handset has been damaged.
 - If the product exhibits a distinct change in performance.
15. Avoid using a telephone (other than cordless) during an electrical storm. There is a remote risk of electric shock from lightning.
 16. Do not use the telephone to report a gas leak in the vicinity of the leak. Under certain circumstances, a spark may be created when the adapter is plugged into the power outlet, or when the handset is replaced in its cradle. This is a common event associated with the closing of any electrical circuit. The user should not plug the phone into a power outlet, and should not put a charged handset into the cradle, if the phone is located in an environment containing concentrations of flammable or flame-supporting gases, unless there is adequate ventilation. A spark in such an environment could create a fire or explosion. Such environments might include: medical use of oxygen without adequate ventilation; industrial gases (cleaning solvents; petrol vapours; etc.); a leak of natural gas; etc.
 17. Only put the handset of your telephone next to your ear when it is in normal talk mode.
 18. The power adapters are intended to be correctly oriented in a vertical or floor mount position. The prongs are not designed to hold the plug in place if it is plugged into a ceiling, under-the-table or cabinet outlet.
 19. Use only the power cord and batteries indicated in this manual. Do not dispose of batteries in a fire. They may explode. Check with local codes for possible special disposal instructions.
 20. In wall mounting position, make sure to mount the telephone base on the wall by aligning the eyelets with the mounting studs of the wall plate. Then slide the telephone base down on both mounting studs until it locks into place. Refer to the full instructions in Installation in the user's manual.
 21. This product should be mounted at a height of less than 2 meters.
 22. Listed PoE (The product is considered not likely to require connection to an Ethernet network with outside plant routing).

   CAUTIONS

- Keep small metallic objects such as pins and staples away from the handset receiver;
- For pluggable equipment, the socket-outlet (power adapter) shall be installed near the equipment and shall be easily accessible;
- The applied nameplate is located at the bottom of the product;
- The equipment is only used for mounting at heights < 2m.

SAVE THESE INSTRUCTIONS

TABLE OF CONTENTS

- Important safety instructions.....2**
- Parts check list5**
- Telephone layout6**
- Installation.....7**
- Telephone settings10**
 - Voice Menu11
- Telephone operation12**
- Appendix13**
 - Troubleshooting13
 - VTech Hospitality Limited Warranty Program16
 - Maintenance18
 - Disclaimer and Limitation of Liability18
 - European Directives18
 - Declaration of Conformity18
 - Disposal of batteries and product.....19
- Technical specifications21**

Parts check list

Items contained in the **corded telephone** package:

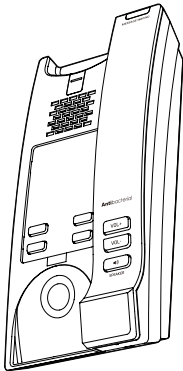
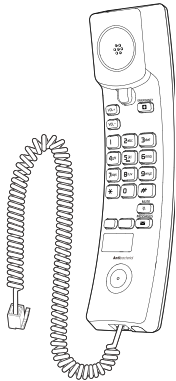
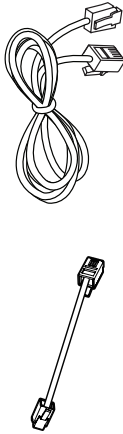
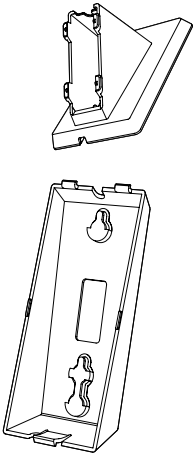
MODEL NAME	MODEL NUMBER	PARTS INCLUDED			
		TELEPHONE BASE WITH FACEPLATE AND OVERLAY	CORDED HANDSET	ETHERNET CABLE	BASE STAND MOUNTING BRACKET
Trimstyle SIP corded 1-Line	CTM-S2315				

Telephone layout

SIP Corded Trimstyle 1-line CTM-S2315

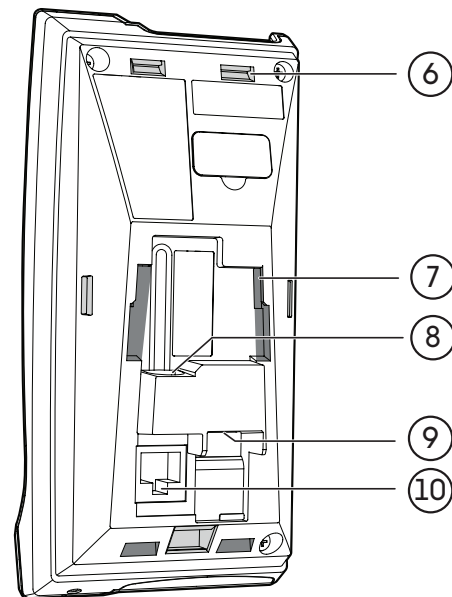
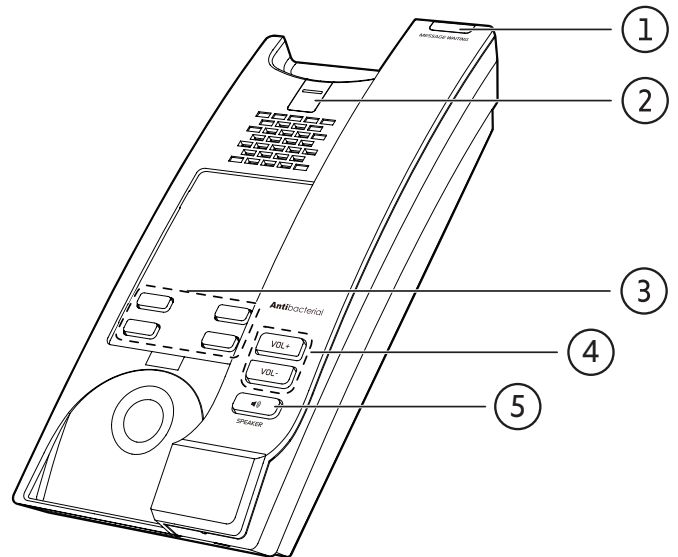
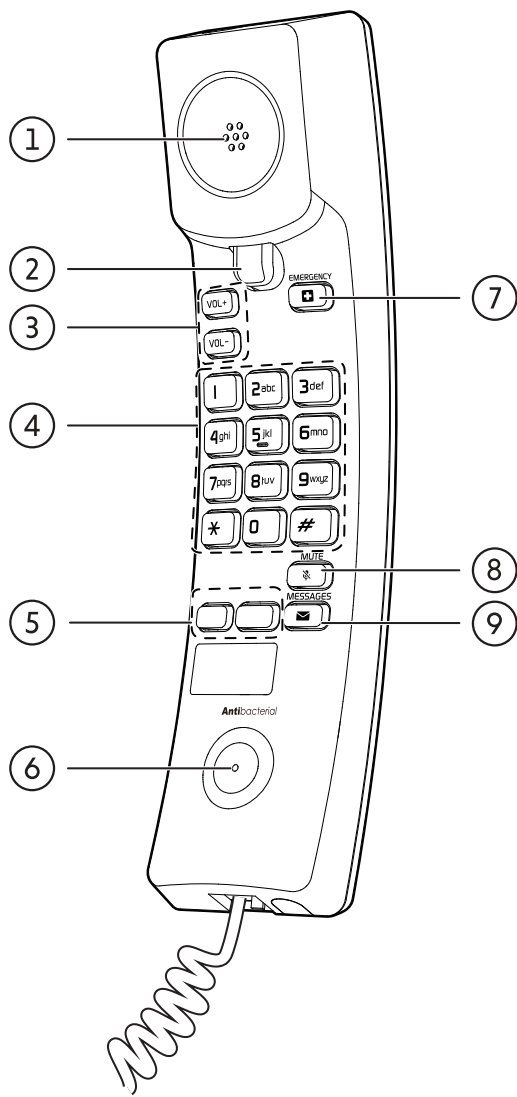

1	Corded handset earpiece
2	Switch hook
3	VOLUME + VOLUME -
4	Numeric dial keys
5	Speed dial keys Programmable key #1 Programmable key #2
6	Microphone
7	EMERGENCY
8	MUTE
9	MESSAGES

1	MESSAGE WAITING LED
2	Wall mount clip
3	Speed dial keys Programmable key #5 Programmable key #6 Programmable key #7 Programmable key #8
4	VOLUME + VOLUME -
5	SPEAKER
6	Grooves for mounting bracket
7	Grooves for base stand
8	Power adapter input
9	Coiled handset cord jack
10	Ethernet cable

Installation

SIP Corded Trimstyle 1-line CTM-S2315

TELEPHONE BASE INSTALLATION

INSTALLATION OPTION - DESKTOP POSITION

1. Turn the telephone base over with the bottom side facing up. Insert the base stand into the lower grooves on the telephone base until they lock securely as shown below.

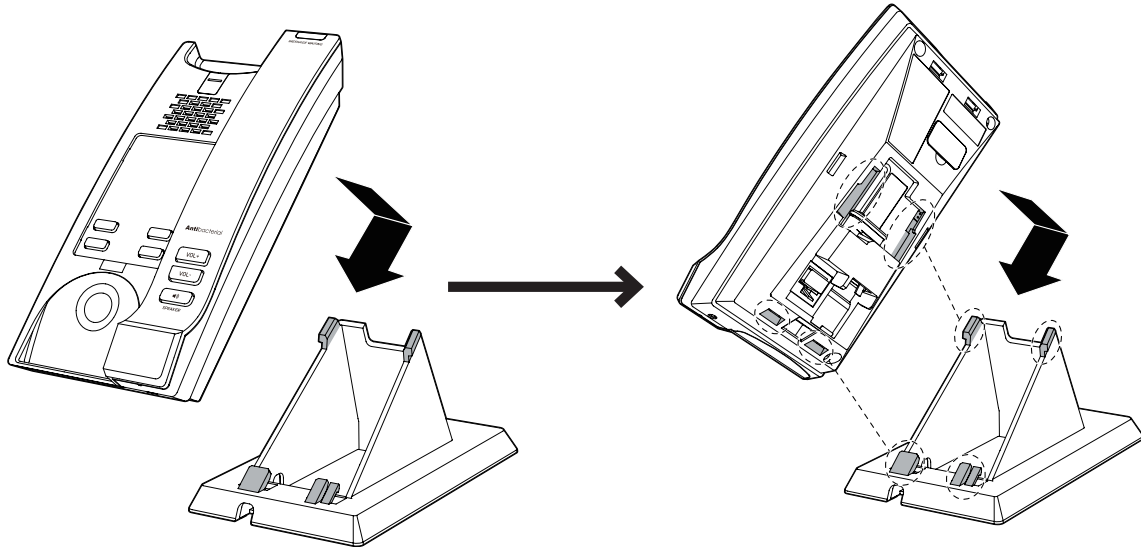

2. Connect both the ethernet cable and coiled handset cord to the telephone base and route them along the wire ducts accordingly. Install the telephone base as shown below.

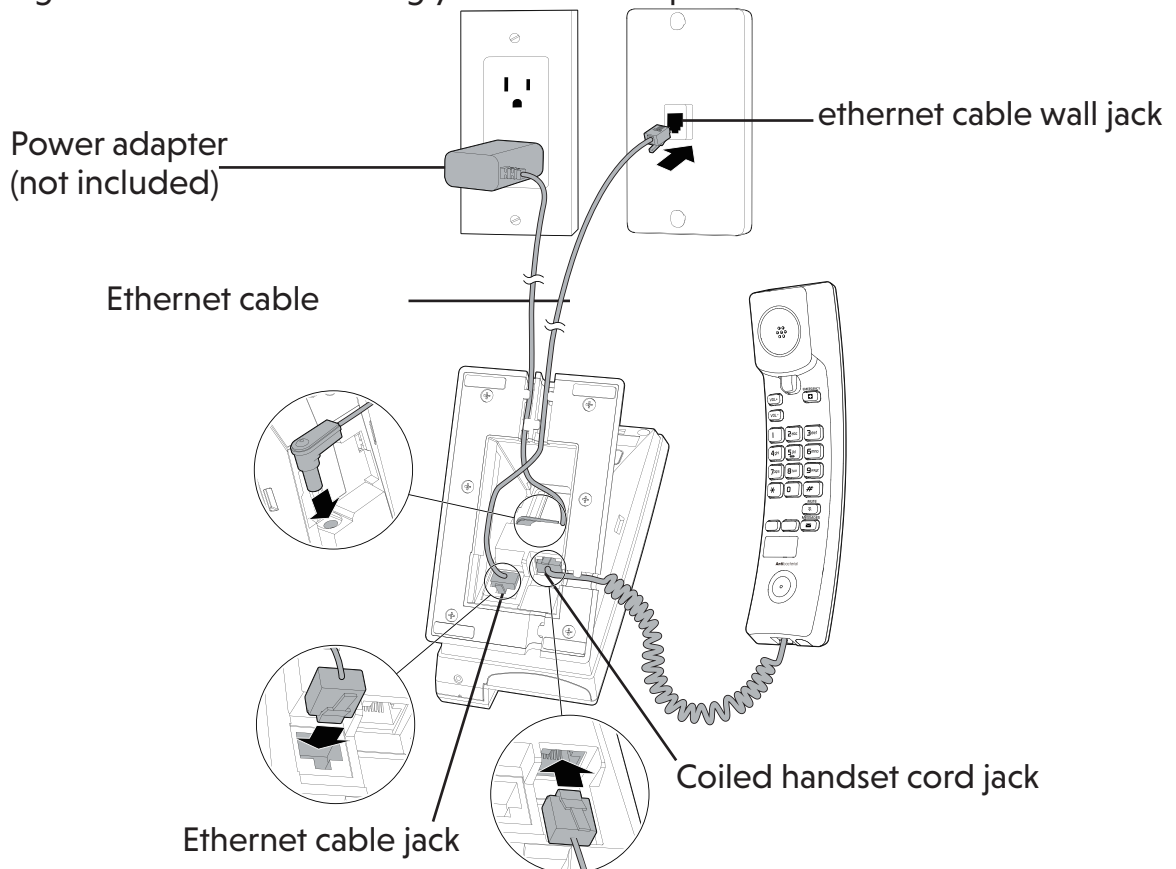

SIP Corded Trimstyle 1-line CTM-S2315

TELEPHONE BASE INSTALLATION

INSTALLATION OPTION - WALL MOUNT POSITION

TO MOUNT THE TELEPHONE BASE ON THE WALL

1. Install the telephone base as shown below.

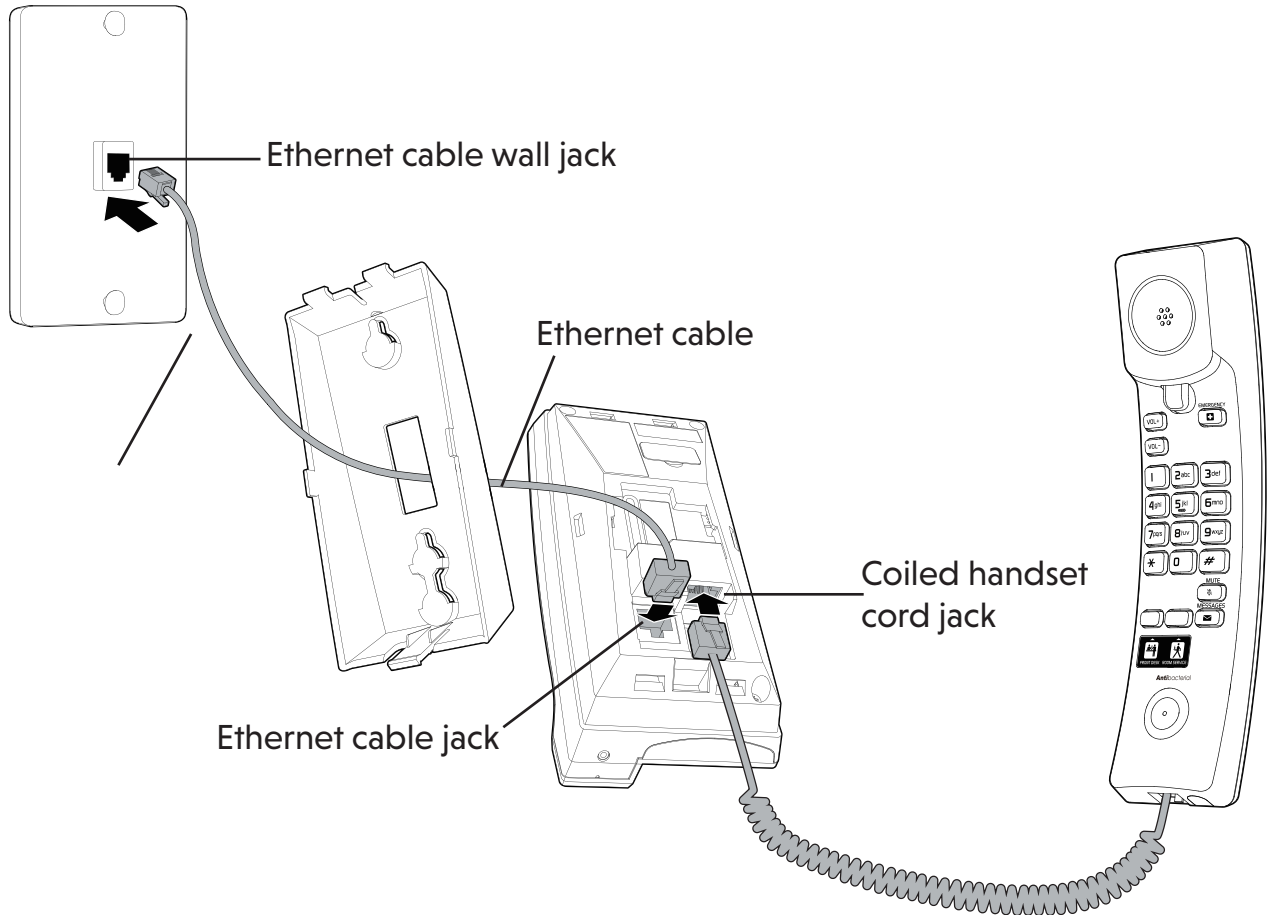

2. Put the corded handset aside. On the telephone base, place a coin in the slit of the wall mount clip and rotate a half turn (180°).

- It locks into place with the protruding edge pointing towards the upper edge of the telephone base. This protruding edge holds the corded handset when the phone is mounted on the wall.

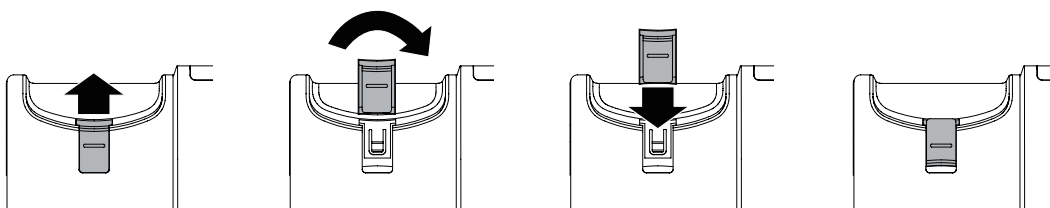

3. Turn the telephone base over with the bottom side facing up. Insert the mounting bracket into the two upper grooves and a lower groove on the telephone base until they lock securely. In the meantime, the ethernet cable sticks out from the rectangular hole. Besides, affix coil handset cord by fitting it in the circular hole at the bottom of the mounting bracket as shown below.

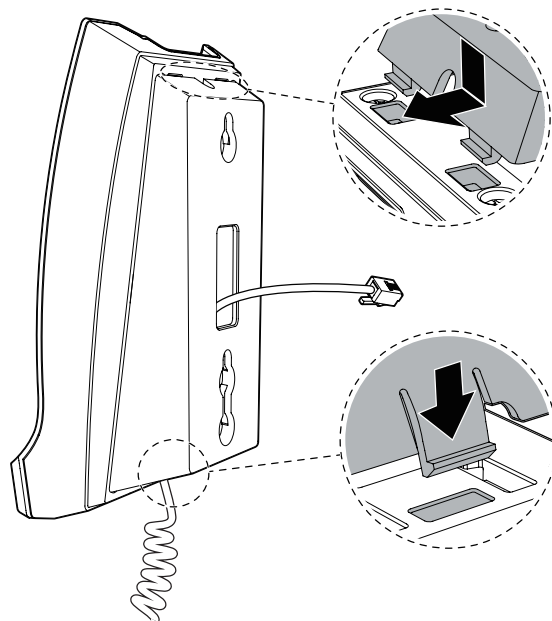

4. Mount the telephone base on the wall by positioning the eyelets on the mounting bracket against the mounting studs. Then, slide the telephone base down on both mounting studs until it locks into place.

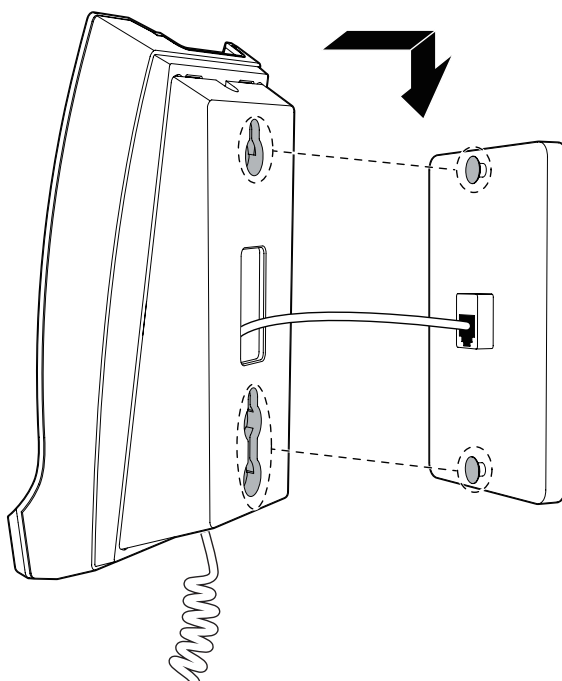

5. Place the corded handset on the telephone base cradle.

Telephone settings

SIP Corded Trimstyle 1-line CTM-S2315

Default settings are indicated by asterisks (*).

SETTING	OPTIONS	ADJUSTABLE BY
Handset earpiece volume	1, 2, 3, 4, 5, 6*, 7, 8	User and administrator
Speakerphone volume	1, 2, 3, 4, 5, 6*, 7, 8	User and administrator
Ringer tone	Tone 1*, Tone 2, Tone 3	Administrator only

All telephone settings are programmed through the administrative web portal. Please refer to the SIP Phone Configuration Guide for details.

Voice Menu

The Voice menu enables you to use the handset to query and change phone settings.

To access the Voice Menu:

1. When the phone is idle, lift the corded handset from the telephone base.
2. Press this key sequence on the handset: * * * *.
A digitized voice on the handset will announce Voice Menu options.
3. Press the number key on the handset to select the desired menu option, or enter information. A list of menu options is shown in the diagram below
For example, to find out the IP address of the phone, press **1** for Network Configuration, then press **2** for IP Address.
4. When you are finished with the Voice menu, place the handset in the cradle.

NOTE: if you changed any network settings, your phone will automatically reboot. This will enable your new settings to take effect.

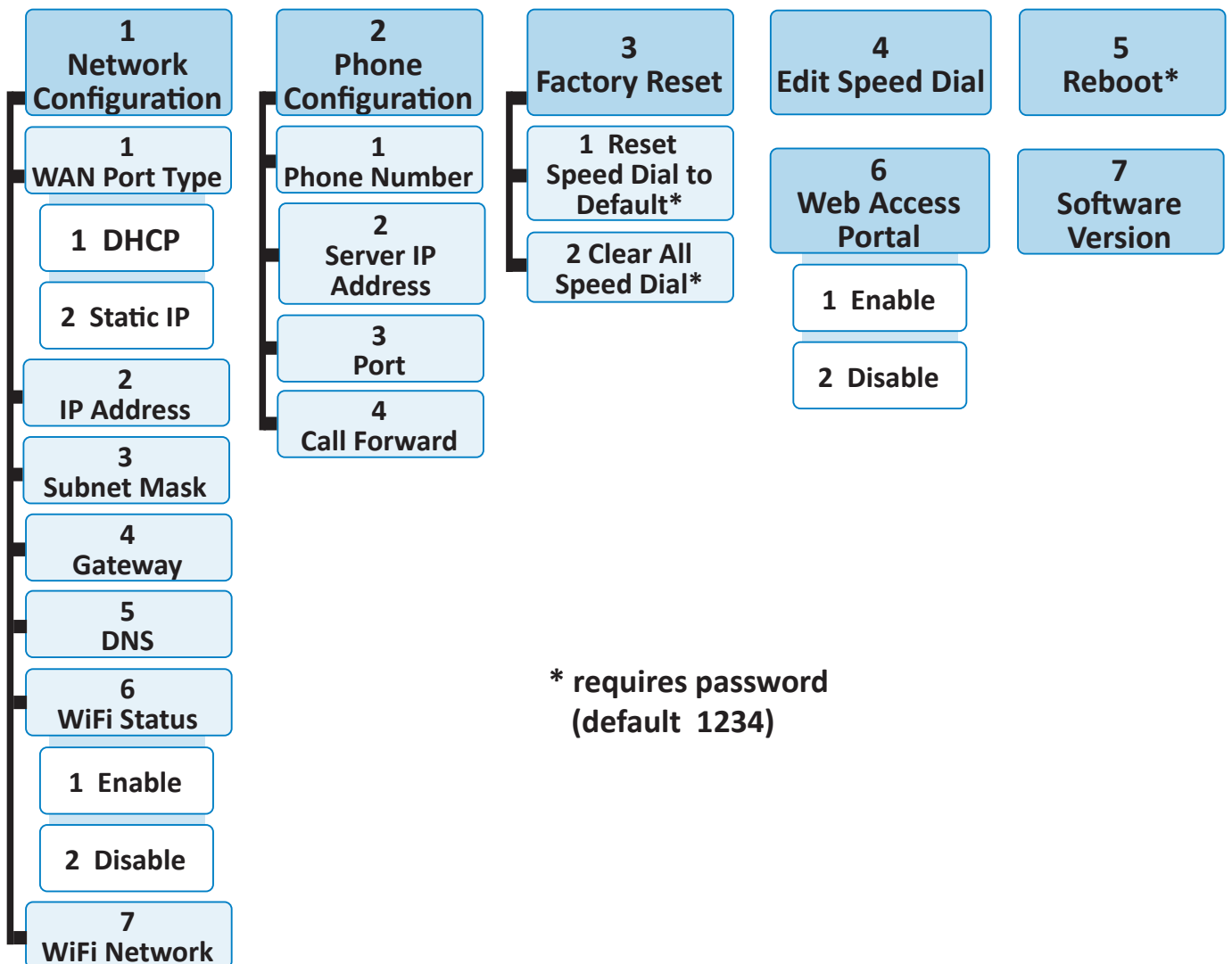



Telephone operation

SIP Corded Trimstyle 1-line CTM-S2315



RECEIVE A CALL

When there is an incoming call, the telephone rings and the **MESSAGE WAITING** LED flashes.

TO ANSWER A CALL:

Press **SPEAKER**  or lift the corded handset from the telephone base to answer. The **MESSAGE WAITING** LED illuminates when the phone line is in use. The **SPEAKER**  key illuminates when in speakerphone mode.





PLACE A CALL

Press **SPEAKER**  or lift the corded handset from the telephone base. Listen for a dial tone and then dial the desired number. The **MESSAGE WAITING** LED illuminates when the phone line is in use. The **SPEAKER**  key illuminates when in speakerphone mode.

END A CALL

Place the corded handset on the telephone base or press **SPEAKER**  if you are in speakerphone mode.

SPEAKERPHONE

1. During a call, press **SPEAKER**  to switch a call between the corded handset earpiece and the speakerphone. The **SPEAKER**  key illuminates when in use.
2. In idle mode, press **SPEAKER**  to activate the speakerphone mode and **SPEAKER**  key illuminates when in speakerphone mode.

VOLUME

Listening volume can be adjusted from the corded handset and ringer volume can be adjusted from the telephone base.

TO ADJUST THE LISTENING VOLUME:

During a call, press **VOL+ / VOL-** to adjust the listening volume. The next call returns to the default listening volume.

TO ADJUST THE RINGER VOLUME:

In idle mode, press **VOL+ / VOL-** to adjust the ringer volume.

MESSAGE WAITING INDICATOR





When a voice message is received, the **MESSAGE WAITING LED** on the telephone base flashes.

PLAY MESSAGES

Press **MESSAGES**  in idle mode to play messages.

MUTE

MUTE THE MICROPHONE

1. During a call, press **MUTE** .
 - The **MUTE**  key illuminates when the mute function is turned on. You can hear the party on the other end but they cannot hear you.
2. Press **MUTE**  again to resume the conversation.
 - The light on the **MUTE**  key turns off.

HOLD

TO PLACE A CALL ON HOLD:

During a call, press the switch hook then release it to hold a call or place a new call.

Appendix

Troubleshooting

If you have difficulty with the telephones, please try the suggestions below.

For customer service, call +44 (0)1706 694 070 or email ukca@trustdistribution.com.

FOR CORDED TELEPHONE

QUESTION	SUGGESTIONS
1. The telephone does not work at all.	<ul style="list-style-type: none">• Make sure a Cat-5 network cable is plugged into the LAN port of the telephone base and the network wall jack with Power over Ethernet (PoE).• Unplug the Cat-5 network cable from the network wall jack. Wait for approximately 15 seconds, then plug it back in.• Disconnect the telephone base from the network wall jack and connect a different working telephone. If the other telephone does not work, the problem is probably in the wiring or network server.
2. There is no dial tone.	<ul style="list-style-type: none">• Try all the above suggestions.• The Cat-5 network cable may be defective. Install a new Cat-5 network cable.• Make sure your network is providing Power over Ethernet (PoE).• Disconnect the telephone base from the network wall jack and connect a different working telephone. If there is no dial tone on this telephone either, the problem is in your wiring or network server.• Make sure the initialization and system registration process completes. The speakerphone key blinks twice every second if there are errors with the initialization and system registration process.
3. I hear other calls when using the telephone.	<ul style="list-style-type: none">• Disconnect the telephone base from the network wall jack and connect a different working telephone. Check your server settings. If calls are still not clear, the problem is probably in the wiring or network server. Contact your telephone service provider (charges may apply).
4. The Speed Dial key does not work at all.	<ul style="list-style-type: none">• The Speed Dial key may not be properly programmed.

5. I cannot dial out.

- Try all the above suggestions.
- A prefix may be required for dialling some internal or external calls
- Make sure there is a dial tone before dialling. It is normal if the cordless handset takes a second or two to synchronise with the telephone base before producing a dial tone. Wait an extra second before dialling.
- Check your server settings. If other telephones in your hotel are having the same problem, the problem is in the wiring or network server. Contact your telephone service provider (charges may apply).

6. The telephone cannot register to the network server.

- Make sure your network is providing Power over Ethernet (PoE).
- Make sure the initialization and system registration process completes.
- If there is an error during the initialization and system registration process, the / **SPEAKER** key flashes twice every second. Disconnect the Cat-5 network cable from the network wall jack and connect it back into the network wall jack with Power over Ethernet (PoE) to start the initialization and system registration process again.

7. The telephone does not ring when there is an incoming call.

- Make sure the Cat-5 network cable is plugged into the LAN port of the telephone base and the network wall jack with Power over Ethernet (PoE).
- Check your server or telephone administrative settings.
- If other telephones in your hotel are having the same problem, the problem is in the wiring or network server. Contact your telephone service provider (charges may apply).
- Other electronic products such as HAM radios and other DECT phones can cause interference with your cordless phone. Try installing your phone as far away as possible from these types of electronic devices.
- The Cat-5 network cable may be defective. Install a new Cat-5 network cable.

QUESTION	SUGGESTIONS
8. I hear other calls when using the telephone.	<ul style="list-style-type: none">• Disconnect the telephone base from the network wall jack and connect and connect a different working telephone. Check your server settings. If calls are still not clear, the problem is probably in the wiring or network server. Contact your telephone service provider (charges may apply).
9. There is interference during a telephone conversation.	<ul style="list-style-type: none">• If your telephone is plugged in with a modem or a surge protector, plug the telephone (or modem/surge protector) into a different location. If this doesn't solve the problem, relocate your telephone or modem farther apart from each other, or use a different surge protector.• Disconnect the telephone base from the telephone wall jack. Plug in a different telephone. If calls are still not clear, the problem is probably in the wiring or telephone service. Contact your telephone service provider (charges may apply).• If other telephones in your hotel are having the same problem, the problem is in the wiring or telephone service. Contact your telephone service provider (charges may apply).
10. The cordless handset beeps and is not performing normally.	<ul style="list-style-type: none">• Make sure the Cat-5 network cable is plugged into the LAN port of the telephone base and the network wall jack with Power over Ethernet (PoE).• Check your server or telephone administrative settings.• Disconnect the telephone base from the network wall jack and connect a different working telephone. If the other telephone has the same problem, the problem is in the wiring or network server. Contact your telephone service provider (charges may apply).• Other electronic products such as HAM radios and other DECT phones can cause interference with your cordless phone. Try installing your phone as far away as possible from these types of electronic devices.

VTech Hospitality Limited Warranty Program

VTech Telecommunications Limited, the manufacturer of VTech Hospitality Product ("Product"), warrants to the holder of a valid proof of purchase ("end user" or "you") that the Product and all accessories provided by VTech in the Product's package are free from defects in material and workmanship, pursuant to the following terms and conditions, when installed and used normally and in accordance with the Product's operating instructions. The limited warranty extends to the end user of this Product and applies only if such Product is purchased through a local distributor /dealer. The limited warranty period for this Product is determined based on the following:

During the limited warranty period, VTech's authorised service representative will repair or replace, at VTech's option, without charge, a Product that is not free from defects in materials and workmanship. If VTech's authorised service representative repairs the Product, new or refurbished replacement parts may be used. If the Product is replaced, it may be replaced with a new or refurbished Product of the same or similar design. Repair or replacement of Product, at VTech's option, is the exclusive remedy.

The limited warranty period for the Product begins on the date that the end user takes possession of the Product. This limited warranty also applies to repaired or replacement Products for a period of either: (a) 90 days from the date the repaired or replacement Product is shipped to you; or (b) the time remaining on the original limited warranty as described above; whichever is longer.

This limited warranty does not cover:

1. Product or parts that have been subjected to misuse, accident, shipping or other physical damage, improper installation, abnormal operation or handling, neglect, inundation,

fire, water or other liquid intrusion; or

2. Product that has been damaged due to repair, alteration or modification by anyone other than an authorised service representative of VTech; or
3. Product to the extent that the problem experienced is caused by signal conditions, network reliability or cable or antenna systems; or
4. Product to the extent that the problem is caused by use with non-VTech accessories; or
5. Product whose warranty/quality stickers, product serial number plates or electronic serial numbers have been removed, altered or rendered illegible; or
6. Product purchased, used, serviced, or shipped for repair from outside the local dealer / distributor, or used for non-approved commercial or institutional purposes (including but not limited to Products used for rental purposes); or
7. Product returned without valid proof of purchase; or
8. Charges or costs incurred by the end user, and risk of loss or damage, in removing and shipping the Product, or for installation or set up, adjustment of customer controls, and installation or repair of systems outside the unit.
9. Line cords or coil cords, plastic overlays, connectors, power adapters and batteries, if the Product is returned without them. VTech will charge the end user at then-current prices for each of the missing items.
10. NiCd or NiMH handset batteries, or power adapters, which, under all circumstances, are covered by a one (1) year warranty only.

Except as provided by applicable law, you assume the risk of loss or damage during transit and transportation and are responsible for delivery or handling charges incurred in the

transport of Product(s) to the service location. VTech's authorised service representative will return repaired or replaced product under this limited warranty to you, transportation, delivery and handling charges prepaid. VTech assumes no risk for damage or loss of the Product in transit.

If the Product failure is not covered by this limited warranty, or proof of purchase does not meet the terms of this limited warranty, VTech will notify you and will request that you authorise the cost of repair and return shipping costs for the repair of Products that not covered by this limited warranty. You must pay for the cost of repair and return shipping costs for the repair of Products that are not covered by this limited warranty.

OTHER LIMITATIONS

This warranty is the complete and exclusive agreement between you and VTech. It supersedes all other written or oral communications related to this Product. VTech provides no other warranties for this Product, whether express or implied, oral or written, or statutory. The warranty exclusively describes all of VTech's responsibilities regarding the Product. No one is authorised to make modifications to this warranty and you should not rely on any such modification.

VTech's liability to end user hereunder shall not exceed the purchase price of the Product. In no event shall VTech be liable for any indirect, special, incidental, consequential, or similar damages (including, but not limited to lost profits or revenue, inability to use the product, or other associated equipment, the cost of substitute equipment, and claims by third parties) resulting from the use of this Product. Some local dealers / distributors do not allow the exclusion or limitation of incidental or consequential damages, so the above limitation or exclusion may not apply to you.

This warranty gives you specific legal rights, and you also have other rights which vary from local dealer / distributor to local dealer / distributor.

Appendix

Maintenance

TAKING CARE OF YOUR TELEPHONE

Your telephone contains sophisticated electronic parts, so it must be treated with care.

AVOID ROUGH TREATMENT

Place the handset down gently. Save the original packing materials to protect your telephone if you ever need to ship it.

AVOID WATER

Your telephone can be damaged if it gets wet. Do not use the handset outdoors in the rain, or handle it with wet hands. Do not install the telephone base near a sink, bathtub or shower.

ELECTRICAL STORMS

Electrical storms can sometimes cause power surges harmful to electronic equipment. For your own safety, take caution when using electrical appliances during storms.

CLEANING YOUR TELEPHONE

Your telephone has a durable plastic casing that should retain its luster for many years. Clean it only with a soft cloth slightly dampened with water or mild soap. Do not use excess water or cleaning solvents of any kind.

Remember that electrical appliances can cause serious injury if used when you are wet or standing in the water. If the telephone base should fall into the water, **DO NOT RETRIEVE IT UNTIL YOU UNPLUG THE NETWORK CABLE FROM THE WALL.** Then remove the telephone by the unplugged cords.

Disclaimer and Limitation of Liability

VTech Telecommunications Limited and its suppliers assume no responsibility for any damage or loss resulting from the use of this user's manual. VTech Telecommunications Limited and its suppliers assume no responsibility for any loss or claims by third parties that may arise through the use of this product. VTech Telecommunications Limited and its suppliers assume no responsibility for any damage or loss caused by deletion of data as a result of malfunction, or repairs. Be sure to make backup copies of important data on other media to protect against data loss.

REMEMBER THAT ELECTRICAL APPLIANCES CAN CAUSE SERIOUS INJURY IF USED WHEN YOU ARE WET OR STANDING IN WATER. IF THE TELEPHONE BASE SHOULD FALL INTO WATER, DO NOT RETRIEVE IT UNTIL YOU UNPLUG THE POWER CORD AND/OR ETHERNET CABLE FROM THE WALL. THEN REMOVE THE TELEPHONE BY THE UNPLUGGED CORDS.

European Directives

This equipment is compliant with 2014/53/EU (RED) and 2011/65/EU (ROHS).

Declaration of Conformity

The Declaration of Conformity may be obtained from: www.vtechhotelphones.com.



Disposal of batteries and product

These symbols (①, ②) on the products, packaging, and/or accompanying documents mean that used electrical and electronic products and batteries must not be mixed with general household waste.

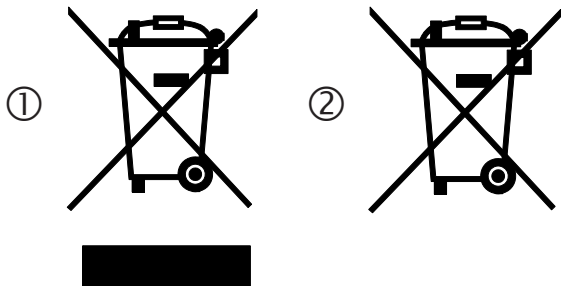

For proper treatment, recovery and recycling of old products and batteries, please take them to applicable collection points in accordance with your national legislation.

By disposing of them correctly, you will help to save valuable resources and prevent any potential negative effects on human health and the environment.

For more information about collection and recycling, please contact your local municipality. Penalties may be applicable for incorrect disposal of this waste, in accordance with national legislation.

PRODUCT DISPOSAL INSTRUCTIONS FOR BUSINESS USERS

If you wish to discard electrical and electronic equipment, please contact your dealer or supplier for further information.

INFORMATION ON DISPOSAL IN OTHER COUNTRIES OUTSIDE THE EUROPEAN UNION

These symbols (①, ②) are only valid in the European Union. If you wish to discard these items, please contact your local authorities or dealer and ask for the correct method of disposal.

NOTE FOR THE BATTERY SYMBOL

This symbol (②) might be used in combination with a chemical symbol. In this case it complies with the requirement set by the Directive for the chemical involved.

Appendix

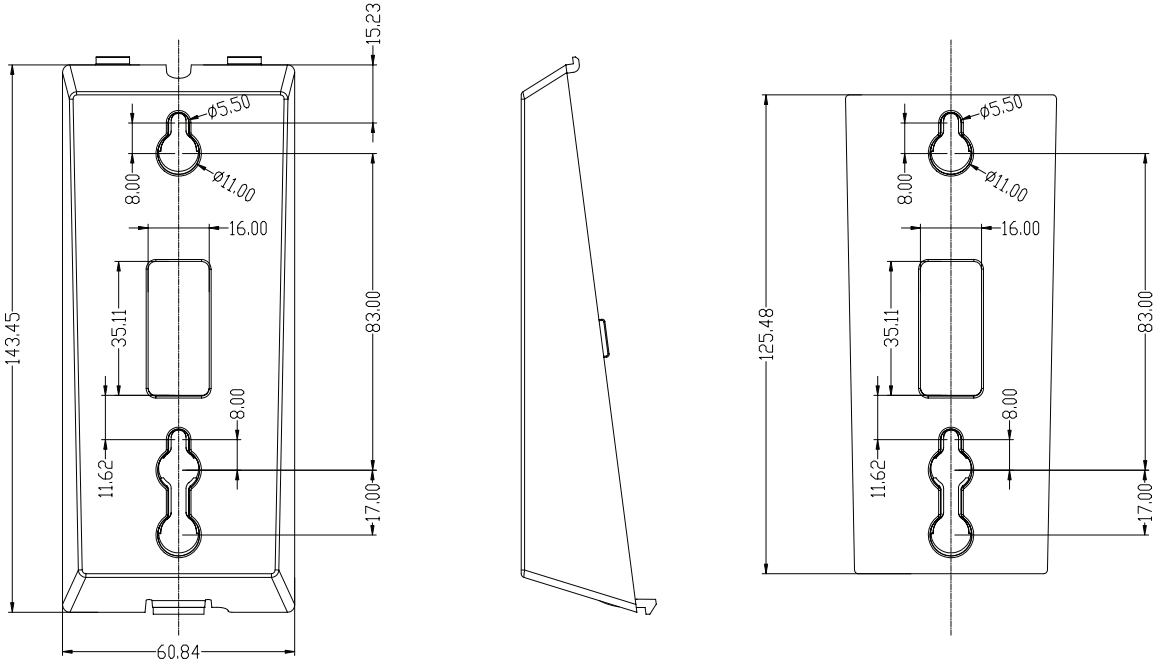

Single Drawing(Scale 1:1)

Technical specifications

SIP Corded Trimstyle - CTM-S2315



Power requirement

Telephone base: Power over Ethernet (PoE) IEEE 802.3af class 2 (48V)

If PoE not available, power adapter (sold separately):

- Input: 100-240V~ 50/60Hz 0.5A Output: 5V DC @ 2.0A
- Manufacturer: VT-PLII
- Model identifier: VT07EEU05200 (EU), VT07EUK05200 (UK)
- Use only the power adapter indicated above for the telephone base unit

Message waiting signal

SIP messaging RFC 3261

Speed Dial memory

Telephone base: up to 4 memory locations; up to 32 digits

Handset: up to 4 memory locations; up to 32 digits

Size

Telephone base: 153.8 x 78.5 x 136.6 mm (6.1 x 3.1 x 5.4 inches)

Corded handset: 48.4 x 212.9 x 41.9 mm (1.9 x 8.4 x 1.6 inches)



Specifications are subject to change without notice.
Copyright © 2022
VTech Telecommunications Limited
All rights reserved. 10/22.
CTM-S2315_UG_V1_CEC_EU-UK_2022.10.31