

SIP NEXT GEN SERIES

NG-S3211

SIP Next Gen Corded 1-line Hotel Telephone

NG-S3211W

SIP Next Gen Corded 1-line Wi-Fi Enabled Hotel Telephone

vtech[®]

User 's Guide

IMPORTANT SAFETY INSTRUCTIONS

When using your telephone equipment, basic safety precautions should always be followed to reduce the risk of fire, electric shock and injury, including the following:

1. This product should be installed by a qualified technician.
2. This product should only be connected to the host equipment and never directly to the network such as Public Switch Telephone Network (PSTN) or Plain Old Telephone Services (POTS).
3. Read and understand all instructions.
4. Follow all warnings and instructions marked on the product.
5. Unplug this product from the wall outlet before cleaning. Do not use liquid or aerosol cleaners. Use a damp cloth for cleaning.
6. Do not use this product near water such as near a bath tub, wash bowl, kitchen sink, laundry tub or swimming pool, or in a wet basement or shower.
7. Do not place this product on an unstable table, shelf, stand or other unstable surfaces.
8. Slots and openings in the back or bottom of the telephone base and handset are provided for ventilation. To protect them from overheating, these openings must not be blocked by placing the product on a soft surface such as a bed, sofa or rug. This product should never be placed near or over a radiator or heat register. This product should not be placed in any area where proper ventilation is not provided.
9. This product should be operated only from the type of power source indicated on the marking label. If you are not sure of the type of power supply on the premises, consult your dealer or local power company.
10. Do not allow anything to rest on the power cord. Do not install this product where the cord may be walked on.
11. Never push objects of any kind into this product through the slots in the telephone base or handset because they may touch dangerous voltage points or create a short circuit. Never spill liquid of any kind on the product.
12. To reduce the risk of electric shock, do not disassemble this product, but take it to an authorized service facility. Opening or removing parts of the telephone base or handset other than specified access doors may expose you to dangerous voltages or other risks. Incorrect reassembling can cause electric shock when the product is subsequently used.
13. Do not overload wall outlets and extension cords.
14. Unplug this product from the wall outlet and refer servicing to an authorized service facility under the following conditions:
 - When the power supply cord or plug is damaged or frayed.
 - If liquid has been spilled onto the product.
 - If the product has been exposed to rain or water.
 - If the product does not operate normally by following the operating

instructions. Adjust only those controls that are covered by the operation instructions. Improper adjustment of other controls may result in damage and often requires extensive work by an authorized technician to restore the product to normal operation.

- If the product has been dropped and the telephone base and/or handset has been damaged.
- If the product exhibits a distinct change in performance.

15. Avoid using a telephone (other than cordless) during an electrical storm. There is a remote risk of electric shock from lightning.

16. Do not use the telephone to report a gas leak in the vicinity of the leak. Under certain circumstances, a spark may be created when the adapter is plugged into the power outlet, or when the handset is replaced in its cradle. This is a common event associated with the closing of any electrical circuit. The user should not plug the telephone into a power outlet, and should not put a charged handset into the cradle, if the telephone is located in an environment containing concentrations of flammable or flame-supporting gases, unless there is adequate ventilation. A spark in such an environment could create a fire or explosion. Such environments might include: medical use of oxygen without adequate ventilation; industrial gases (cleaning solvents; gasoline vapors; etc.); a leak of natural gas; etc.

17. Only put the handset of your telephone next to your ear when it is in normal talk mode.

18. The power adapters are intended to be correctly oriented in a vertical or floor

mount position. The prongs are not designed to hold the plug in place if it is plugged into a ceiling, under-the-table or cabinet outlet.

19. Use only the power cord and batteries indicated in this manual. Do not dispose of batteries in a fire. They may explode. Check with local codes for possible special disposal instructions.

20. In wall mounting position, make sure to mount the telephone base on the wall by aligning the eyelets with the mounting studs of the wall plate. Then slide the telephone base down on both mounting studs until it locks into place. Refer to the full instructions in Installation in the user's manual.

21. This product should be mounted at a height of less than 2 meters.

22. Listed PoE (The product is considered not likely to require connection to an Ethernet network with outside plant routing).

⚠ CAUTIONS

- Keep small metallic objects such as pins and staples away from the handset receiver.

SAVE THESE INSTRUCTIONS

Do not install the product at a height above 2 meters.

Name plate label marked on the bottom of base unit.



Use only specified power adapter, manufacturer VT-PLII, model VT07EUS05200.

For PLUGGABLE EQUIPMENT, the socket-outlet shall be installed near the equipment and shall be easily accessible.

INSTRUCTIONS DE SÉCURITÉ IMPORTANTES

Lorsque vous utilisez votre équipement téléphonique, des précautions de base doivent toujours être prises pour réduire les risques d'incendie, d'électrocution et de blessure, notamment les suivantes :

1. Ce produit doit être installé par un technicien qualifié.
2. Ce produit ne doit être connecté qu'à l'équipement hôte et jamais directement au réseau tel que le réseau téléphonique public commuté (RTPC) ou les services téléphoniques classiques (POTS).
3. Lire et comprendre toutes les instructions.
4. Respecter tous les avertissements et instructions figurant sur le produit.
5. Débranchez ce produit de la prise murale avant de le nettoyer. N'utilisez pas de nettoyants liquides ou en aérosol. Utilisez un chiffon humide pour le nettoyage.
6. N'utilisez pas ce produit près de l'eau, par exemple près d'une baignoire, d'une cuvette de lavage, d'un évier de cuisine, d'une cuve de lavage ou d'une piscine, ou dans un sous-sol ou une douche humide.
7. Ne pas placer ce produit sur une table, une étagère, un support ou toute autre surface instable.
8. Des fentes et des ouvertures à l'arrière ou en-dessous du socle du téléphone et du combiné sont prévues pour la ventilation. Afin de les protéger contre la surchauffe, ces ouvertures ne doivent pas être obstruées en plaçant le produit sur une surface souple comme un lit, un divan ou un tapis. Ce produit ne doit jamais être placé à proximité ou au-dessus d'un radiateur ou d'un registre de chaleur. Ce produit ne doit pas être placé dans un endroit où une ventilation adéquate n'est pas assurée.
9. Ce produit ne doit être utilisé qu'avec le type de source d'énergie indiqué sur l'étiquette de marquage. Si vous n'êtes pas sûr du type d'alimentation électrique sur place, consultez votre revendeur ou votre compagnie d'électricité locale.
10. Ne laissez rien reposer sur le cordon d'alimentation. N'installez pas ce produit à un endroit où l'on pourrait marcher sur le cordon.
11. N'introduisez jamais d'objets de quelque nature que ce soit dans ce produit par les fentes du socle du téléphone ou du combiné, car ils pourraient toucher des points de tension dangereux ou créer un court-circuit. Ne jamais renverser de liquide de quelque nature que ce soit sur le produit.
12. Pour réduire le risque d'électrocution, ne démontez pas ce produit, mais confiez-le à un service après-vente agréé. Ouvrir ou retirer des parties du socle du téléphone ou du combiné autres que les portes d'accès spécifiées peut vous exposer à des tensions dangereuses ou à d'autres risques. Un remontage incorrect peut provoquer une électrocution lors de l'utilisation ultérieure du produit.
13. Ne surchargez pas les prises murales et les rallonges électriques.
14. Débranchez ce produit de la prise murale et confiez l'entretien à un centre de service agréé dans les conditions suivantes :
 - Lorsque le cordon d'alimentation ou la fiche est endommagé ou effiloché.
 - Si du liquide a été renversé sur le produit.
 - Si le produit a été exposé à la pluie ou à l'eau.
 - Si le produit ne fonctionne pas normalement en suivant les instructions d'utilisation. Ne réglez que les commandes qui sont couvertes par le mode d'emploi. Un mauvais réglage des autres commandes peut entraîner des

dommages et nécessite souvent un travail important de la part d'un technicien autorisé pour remettre le produit en état de fonctionnement.

- Si le produit est tombé et que le socle du téléphone et/ou le combiné ont été endommagés.
 - Si le produit présente un changement distinct de performance.
15. Évitez d'utiliser un téléphone (autre que sans fil) pendant un orage électrique. Il existe un risque d'électrocution dû à la foudre.
 16. N'utilisez pas le téléphone pour signaler une fuite de gaz à proximité de la fuite. Dans certaines circonstances, une étincelle peut se produire lorsque l'adaptateur est branché dans la prise de courant, ou lorsque le combiné est replacé dans son berceau. Il s'agit d'un événement courant associé à la fermeture de tout circuit électrique. L'utilisateur ne doit pas brancher le téléphone dans une prise de courant, ni placer un combiné chargé dans son socle, si le téléphone est situé dans un environnement contenant des concentrations de gaz inflammables ou propices aux flammes, à moins qu'il n'y ait une ventilation adéquate. Une étincelle dans un tel environnement pourrait créer un incendie ou une explosion. Ces environnements peuvent comprendre : l'utilisation médicale de l'oxygène sans ventilation adéquate; les gaz industriels (solvants de nettoyage; vapeurs d'essence; etc.); une fuite de gaz naturel; etc.
 17. Ne placez le combiné de votre téléphone près de votre oreille que lorsqu'il est en mode de conversation normal.
 18. Les adaptateurs d'alimentation sont destinés à être correctement orientés en position verticale ou au sol. Les broches ne sont pas conçues pour maintenir la fiche en place si elle est branchée au plafond, sous la table ou dans une prise de courant d'armoire.
 19. Utilisez uniquement le cordon d'alimentation et les piles indiqués dans ce manuel. Ne

jetez pas les piles au feu. Elles risquent d'exploser. Vérifiez auprès des autorités locales les éventuelles instructions spéciales d'élimination.

20. En position de montage mural, veillez à monter le socle du téléphone sur le mur en alignant les oeilletons avec les montants de fixation de la plaque murale. Ensuite, faites glisser le socle téléphonique vers le bas sur les deux montants de montage jusqu'à ce qu'il se verrouille en place. Reportez-vous aux instructions complètes dans la section Installation du guide d'utilisation.
21. Ce produit doit être installé à une hauteur inférieure à 2 mètres.
22. Listé POE (Le produit est considéré comme peu susceptible de nécessiter une connexion à un réseau Ethernet avec un routage extérieur à l'installation).

MISE EN GARDE

- Gardez les petits objets métalliques tels que les épingles et les agrafes loin du combiné.

CONSERVEZ CES INSTRUCTIONS

N'installez pas du produit à une hauteur supérieure à 2 mètres.

Étiquette de la plaque signalétique marquée au bas de l'unité de base.



Utilisez uniquement l'adaptateur, fabricant VT-PLII, model VT07EUS05200.

Pour les équipements enfichables, le prix de courant (adaptateur de courant) devra être installé près de l'équipement et être accessible.

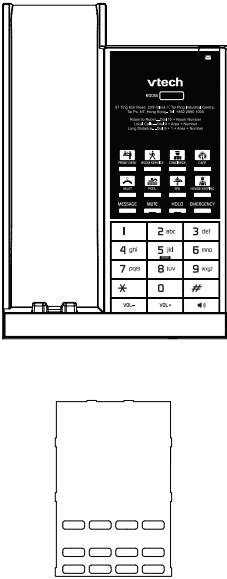
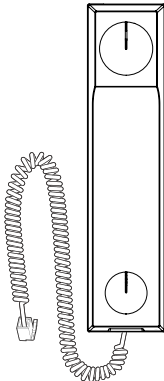
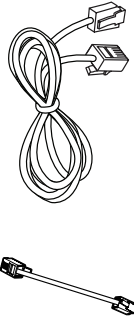
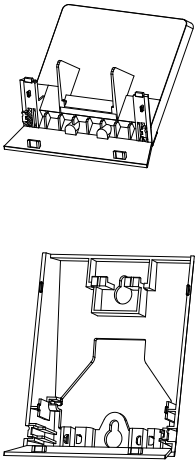
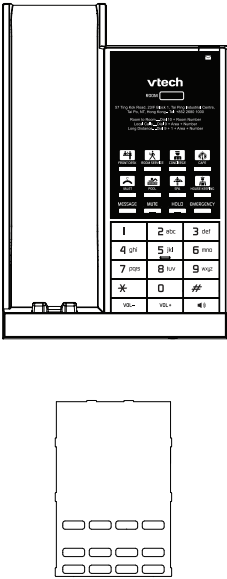
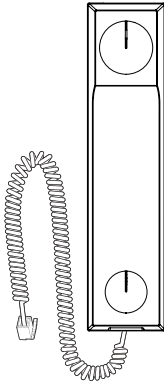

TABLE OF CONTENTS

Important safety instructions.....	2
Instructions de sécurité importantes..	4
Parts check list	7
Telephone layout	8
SIP Next Gen Corded 1-line Hotel Telephone - NG-S3211	8
SIP Next Gen Corded 1-line Wi-Fi Enabled Hotel Telephone - NG-S3211W	8
Telephone layout	9
Installation.....	10
SIP Next Gen Corded 1-line Hotel Telephone - NG-S3211	10
SIP Next Gen Corded 1-line Wi-Fi Enabled Hotel Telephone - NG-S3211W	10
Telephone settings	14
SIP Next Gen Corded 1-line Hotel Telephone - NG-S3211	14
SIP Next Gen Corded 1-line Wi-Fi Enabled Hotel Telephone - NG-S3211W	14
Voice Menu	15

Telephone operation	16
SIP Next Gen Corded 1-line Hotel Telephone - NG-S3211	16
SIP Next Gen Corded 1-line Wi-Fi Enabled Hotel Telephone - NG-S3211W	16
Appendix	18
Troubleshooting	18
VTech Hospitality Limited Warranty Program	21
FCC, ACTA and IC regulations	23
Maintenance	25
Disclaimer and Limitation of Liability	25
Technical specifications	26
SIP Next Gen Corded 1-line Wi-Fi Enabled Hotel Telephone - NG-S3211W	26

Parts check list

Items contained in the **corded telephone** package:

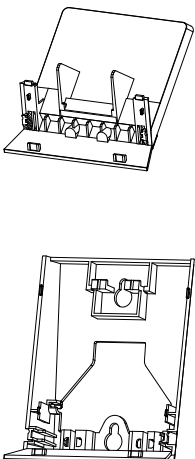
MODEL NAME	MODEL NUMBER	PARTS INCLUDED			
		TELEPHONE BASE WITH OVERLAY	CORDED HANDSET	ETHERNET CABLE SHORT ETHERNET CABLE TELEPHONE BASE POWER ADAPTER	BASE STAND MOUNTING BRACKET
SIP Next Gen Coded 1-line Hotel Telephone	NG-S3211			 power adapter is sold separately	
SIP Next Gen Coded 1-line Wi-Fi Enabled Hotel Telephone	NG-S3211W				

Telephone layout

SIP Next Gen Corded 1-line Hotel Telephone - NG-S3211

SIP Next Gen Corded 1-line Wi-Fi Enabled Hotel Telephone - NG-S3211W

TELEPHONE BASE

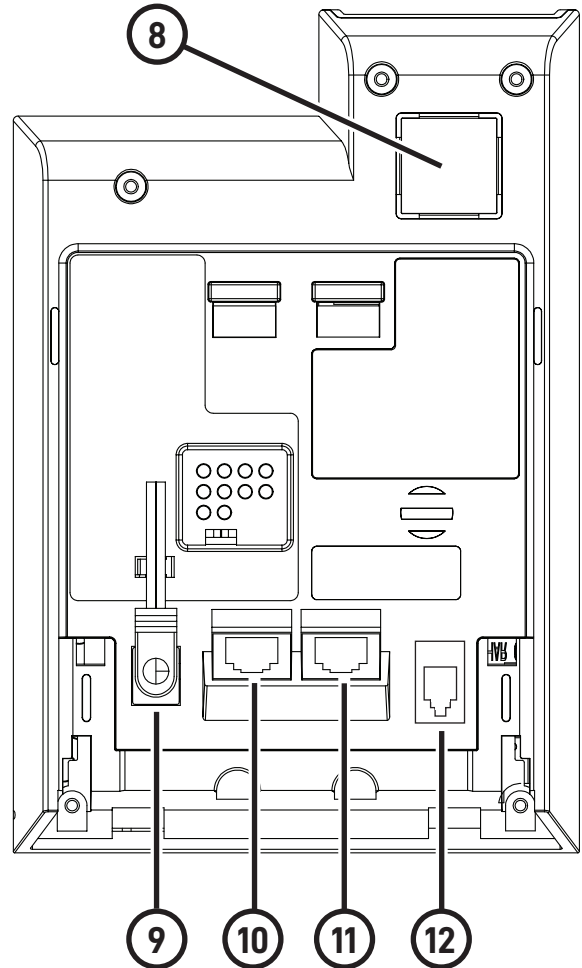
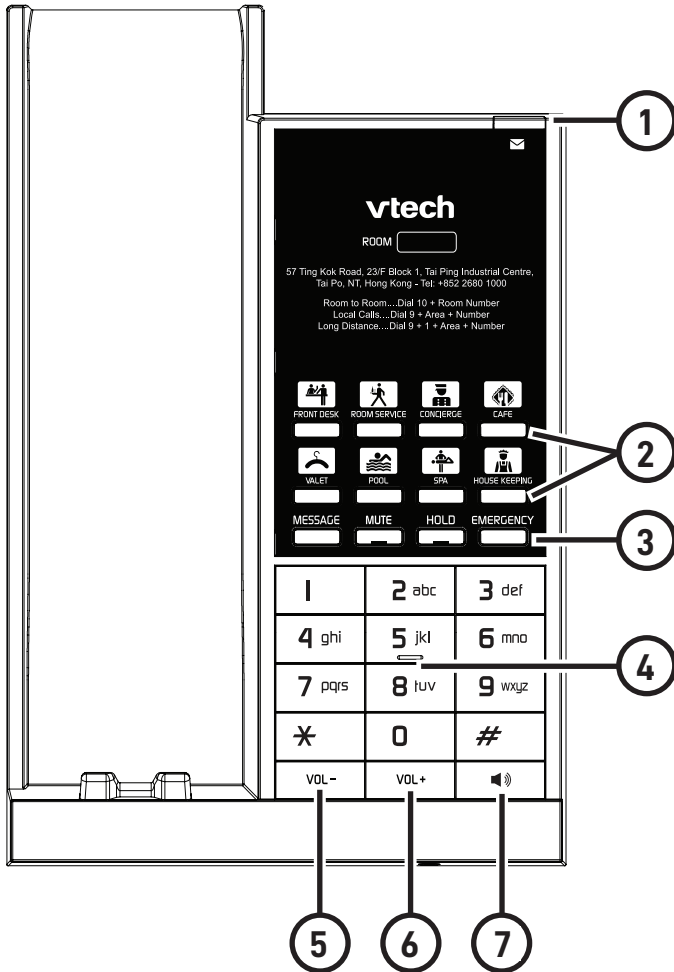

1	Message waiting LED
2	Speed dial keys
3	MESSAGE key
	MUTE key
	HOLD key
	EMERGENCY key
4	Numeric dial keys
5	VOLUME - key
6	VOLUME + key
7	SPEAKER key

8	Speakerphone
9	Power adapter input
10	NET ethernet port
11	PC ethernet port
12	Handset connector jack

Telephone layout

SIP Next Gen Corded 1-line Hotel Telephone - NG-S3211

SIP Next Gen Corded 1-line Wi-Fi Enabled Hotel Telephone - NG-S3211W

HANDSET

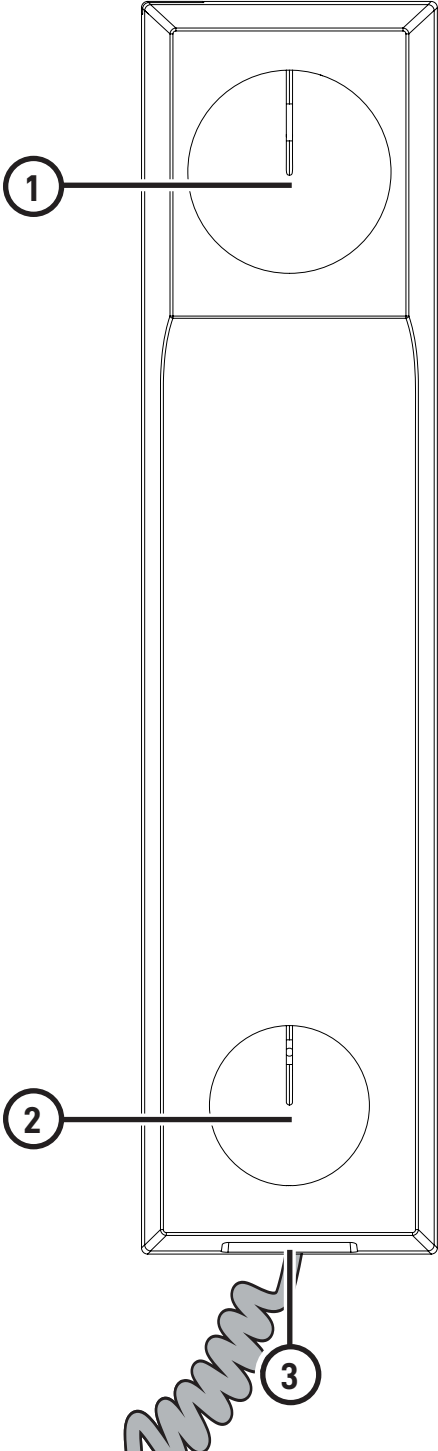

1	Earpiece
2	Microphone
3	Handset cord jack (in the handset's compartment)

Installation

SIP Next Gen Corded 1-line Hotel Telephone - NG-S3211

SIP Next Gen Corded 1-line Wi-Fi Enabled Hotel Telephone - NG-S3211W

TELEPHONE BASE INSTALLATION

1. Connect both the ethernet cable and coiled handset cord to the telephone base and route them along the wire ducts accordingly. Install the telephone base as shown below.

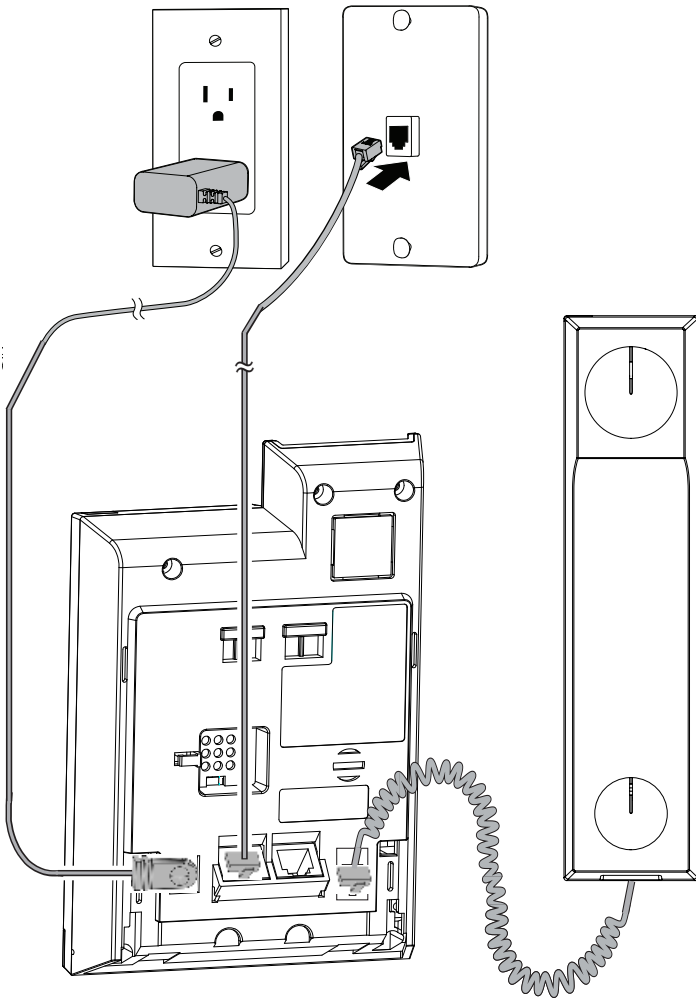

2. If you are connecting a power adapter, make sure it is securely plugged into an outlet not controlled by a wall switch, and the ethernet cable is plugged into the network wall jack.
 - NOTE: Power adapter is not required for Power over Ethernet (PoE).
3. Press **▶▶** on the telephone base. Listen for a dial tone, and then press **▶▶** again to hang

up.

NOTE

- The dial tone will not be played if the SIP account used by this telephone cannot be registered.
- The power adapter is sold separately.
- Use only the power adapter described in "Technical specifications" on page 26.

CAUTION:

Use only the supplied ethernet cables. The supplied ethernet cables are not designed for use in any other IT devices. Misusing them on your other IT devices shall be prohibited. To order a replacement, call 1-888-907-2007.

INSTALLATION OPTION - DESKTOP POSITION

TO MOUNT THE TELEPHONE BASE ON THE BASE STAND

1. Align the grooves of the base stand with the telephone base.
2. Slide the base stand up to secure it.

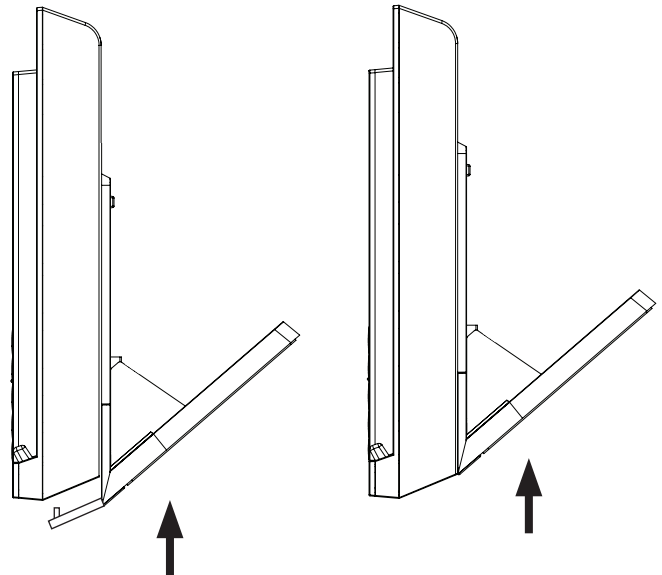

TO UNMOUNT THE BASE STAND

Simply slide the base stand down, and lift it from the telephone base.

INSTALLATION OPTION - CONVERTING FROM DESKTOP TO WALL MOUNT POSITION

TO MOUNT THE TELEPHONE BASE ON THE WALL

1. Unmount the base stand from the telephone base. Disconnect all cords and cables from the telephone base. Put the cordless handset aside.
2. Turn the telephone base over with the bottom side facing up.
3. Align the grooves with the wall mount bracket.
4. Slide the wall mount bracket up.

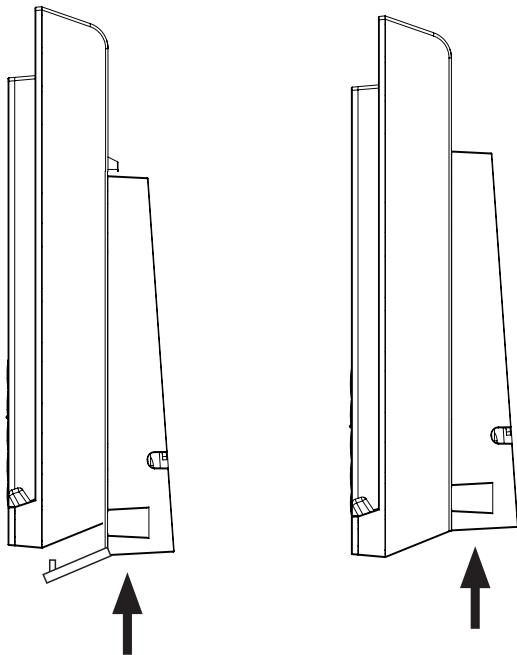

5. Connect the telephone as described in "Telephone base installation" on page 10, but use the short ethernet cable.
6. Route the short ethernet cable, coiled handset cord, and optional power adapter cable along the wire ducts accordingly. These cables and cords stick out from the

hole in the wall mount bracket.

7. Mount the telephone base on the wall by positioning the eyelets on the telephone base and the mounting bracket against the mounting studs. Then slide the telephone base down on both mounting studs until it locks into place.

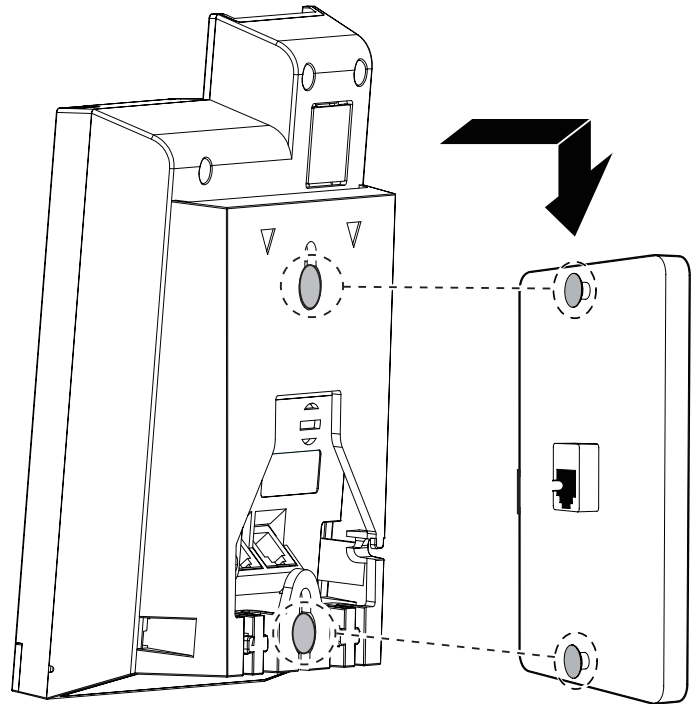

8. Place the handset on the telephone base cradle.

TO REMOVE THE WALL MOUNT BRACKET FROM THE TELEPHONE BASE

1. Slide the telephone base up to remove it from the mounting studs on the wall.
2. Disconnect all cords and cables from the telephone base.
3. Slide the wall mount bracket down and lift it from the telephone base.

WALL MOUNT BRACKET DIMENSIONS

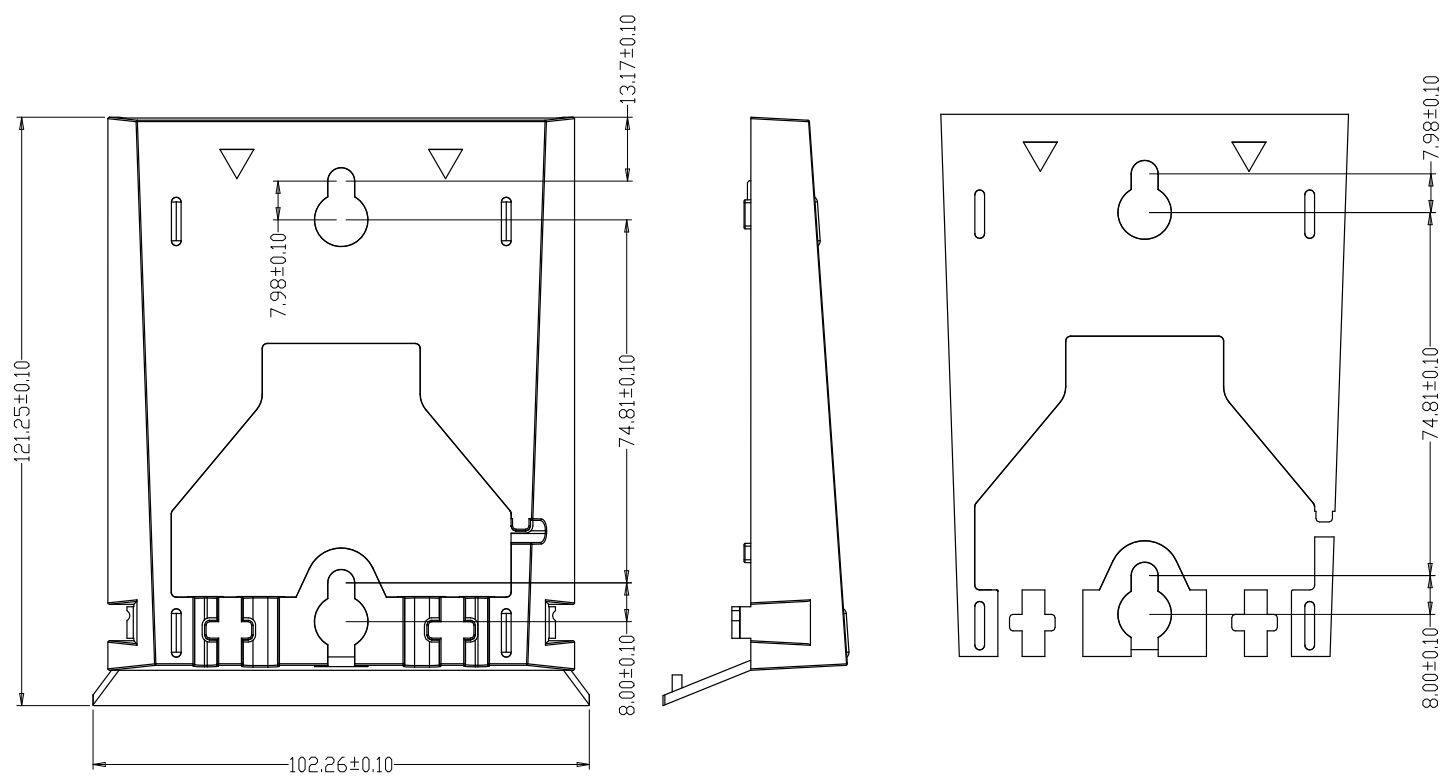

Unit: mm

Installation

SIP Next Gen Corded 1-line Hotel Telephone - NG-S3211

SIP Next Gen Corded 1-line Wi-Fi Enabled Hotel Telephone - NG-S3211W

REPLACING THE COILED HANDSET CORD

1. Hold the handset.
2. Press both thumbs down on the edge of the handset cover near the back of the earpiece, and slide the handset cover downwards.

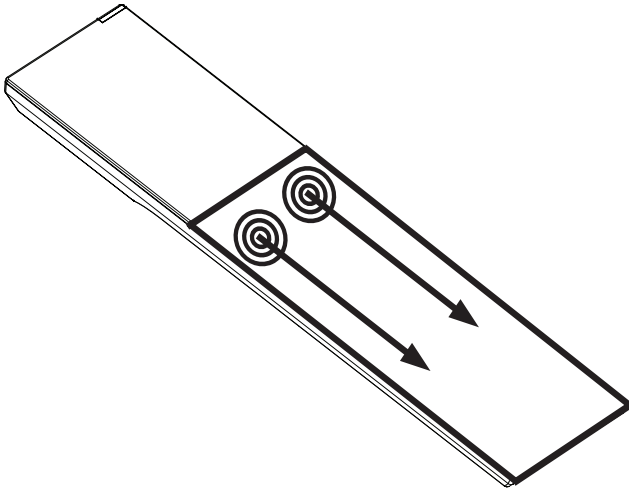

3. Lift the handset cover off the handset.
4. Unplug the coiled handset cord from the handset cord jack.
5. Plug another coiled handset cord into the handset cord jack.
6. Align all the tabs on the handset cover against the corresponding grooves on the handset, then slide the handset cover closed.

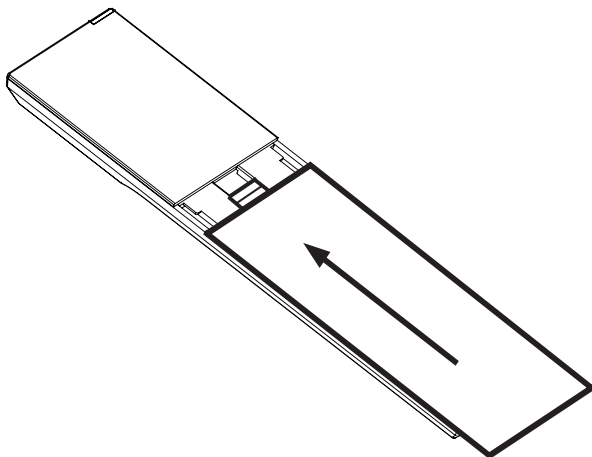

INSTALLATION NOTES

⚠ CAUTION! Please be careful of sharp edges of base stand that can cause harm during the installation process.

Avoid placing the phone too close to:

- Communication devices such as television sets, DVD players, or other cordless telephones
- Excessive heat sources
- Noise sources such as a window with traffic outside, motors, microwave ovens, refrigerators, or fluorescent lighting
- Excessive dust sources such as a workshop or garage
- Excessive moisture
- Extremely low temperature
- Mechanical vibration or shock such as on top of a washing machine or work bench

Telephone settings

SIP Next Gen Corded 1-line Hotel Telephone - NG-S3211

SIP Next Gen Corded 1-line Wi-Fi Enabled Hotel Telephone - NG-S3211W

Default settings are indicated by asterisks (*).

SETTING	OPTIONS	ADJUSTABLE BY
Handset earpiece volume	1, 2, 3, 4, 5, 6*, 7, 8	User and administrator
Speakerphone volume	1, 2, 3, 4, 5, 6*, 7, 8	User and administrator
Ringer tone	Tone 1*, Tone 2, Tone 3	Administrator only

All telephone settings are programmed through the administrative web portal. Please refer to the SIP Phone Configuration Guide for details.

Voice Menu

The Voice menu enables you to use the handset to query and change telephone settings.

To access the Voice Menu:

1. When the telephone is idle, lift the corded handset from the telephone base.
2. Press this key sequence on the handset: * * * *.
A digitized voice on the handset will announce Voice Menu options.
3. Press the number key on the handset to select the desired menu option, or enter information.
A list of menu options is shown in the diagram below.
For example, to find out the IP address of the telephone, press **1** for Network Configuration, then press **2** for IP Address.
4. When you are finished with the Voice menu, place the handset in the cradle.
NOTE: if you changed any network settings, your telephone will automatically reboot.
This will enable your new settings to take effect.

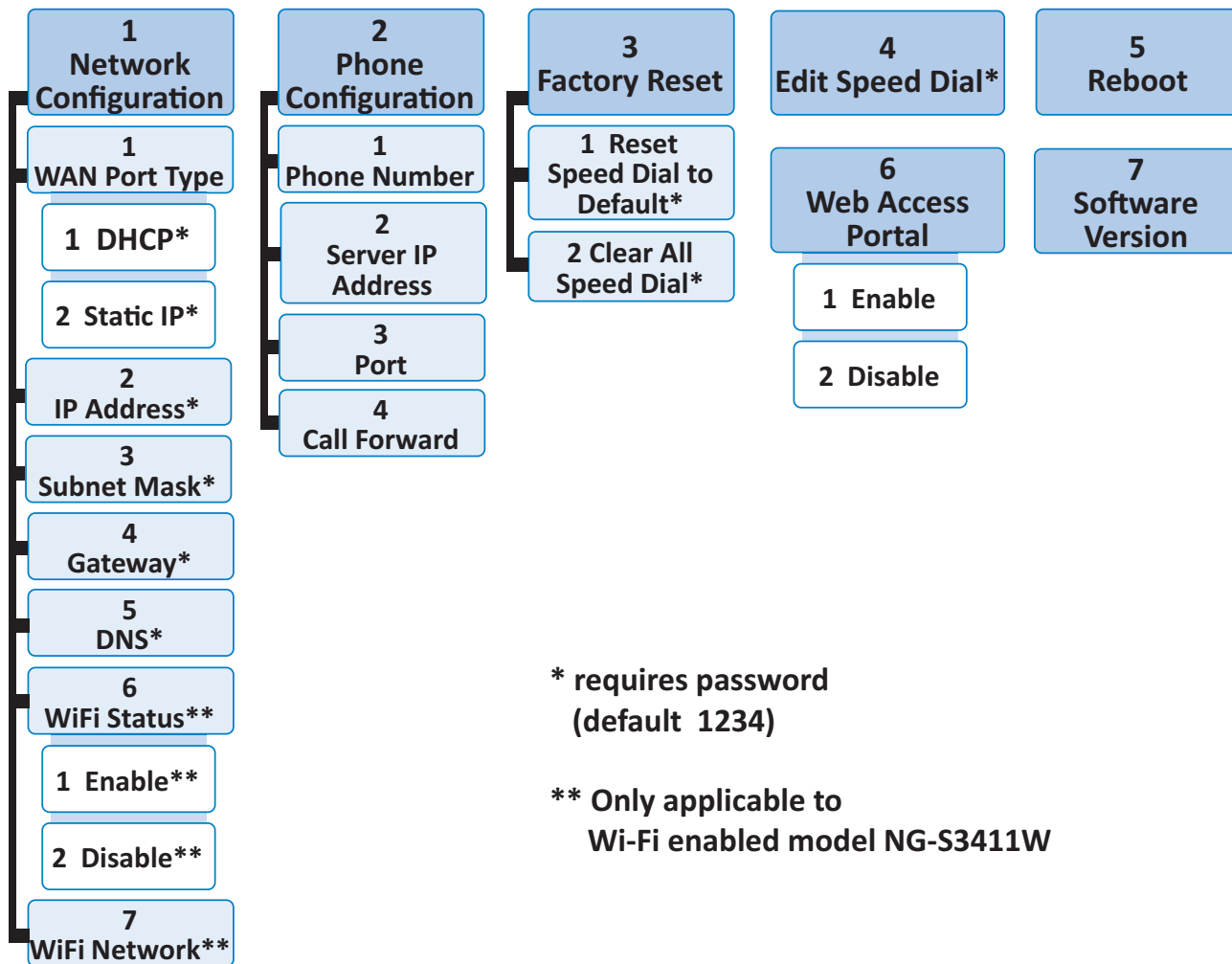

Telephone operation

SIP Next Gen Corded 1-line Hotel Telephone - NG-S3211

SIP Next Gen Corded 1-line Wi-Fi Enabled Hotel Telephone - NG-S3211W



RECEIVE A CALL

When there is an incoming call, the telephone rings and the message waiting LED flashes.

TO ANSWER A CALL:

Press  or lift the corded handset from the telephone base to answer. The  key illuminates when in speakerphone mode.





PLACE A CALL

Press  or lift the corded handset from the telephone base. Listen for a dial tone and then dial the desired number. The  key illuminates when in speakerphone mode.

END A CALL

Place the corded handset on the telephone base or press  if you are in speakerphone mode.

SPEAKERPHONE

1. During a call, press  to switch a call between the corded handset earpiece and the speakerphone.
The  key illuminates when in use.
2. In idle mode, press  to activate the speakerphone mode and  key illuminates when in speakerphone mode.

VOLUME

Listening volume can be adjusted from the corded handset and ringer volume can be adjusted from the telephone base.

TO ADJUST THE LISTENING VOLUME:

During a call, press **VOL+ / VOL-** to adjust the listening volume. The next call returns to the default listening volume.

TO ADJUST THE RINGER VOLUME:

In idle mode, press **VOL+ / VOL-** to adjust the ringer volume.

MESSAGE WAITING INDICATOR

When a voice message is received, the message waiting LED on the telephone base flashes.

PLAY MESSAGES

Press **MESSAGES** in idle mode to play messages.

MUTE

MUTE THE MICROPHONE

1. During a call, press **MUTE**.
 - The **MUTE** key illuminates when the mute function is turned on. You can hear the party on the other end, but they cannot hear you.
2. Press **MUTE** again to resume the conversation.
 - The light on the **MUTE** key turns off.

HOLD

TO PLACE A CALL ON HOLD:

During a call, press the **HOLD** key.

TO TAKE THE CALL OFF HOLD:

Press **HOLD**.

Appendix

Troubleshooting

If you have difficulty with the telephones, please try the suggestions below. For customer service, visit our website at www.vtechhotelphones.com or call 1-888-907-2007.

FOR CORDED TELEPHONE

QUESTION	SUGGESTIONS
The telephone does not work at all.	<ul style="list-style-type: none">• Make sure a Cat-5 network cable is plugged into the LAN port of the telephone base and the network wall jack with Power over Ethernet (PoE).• Unplug the Cat-5 network cable from the network wall jack. Wait for approximately 15 seconds, then plug it back in.• Disconnect the telephone base from the network wall jack and connect a different working telephone. If the other telephone does not work, the problem is probably in the wiring or network server.
There is no dial tone.	<ul style="list-style-type: none">• Try all the above suggestions.• The Cat-5 network cable may be defective. Install a new Cat-5 network cable.• Make sure your network is providing Power over Ethernet (PoE).• Disconnect the telephone base from the network wall jack and connect a different working telephone. If there is no dial tone on this telephone either, the problem is in your wiring or network server.• Make sure the initialization and system registration process completes. The speakerphone key blinks twice every second if there are errors with the initialization and system registration process.
I hear other calls when using the telephone.	<ul style="list-style-type: none">• Disconnect the telephone base from the network wall jack and connect a different working telephone. Check your server settings. If calls are still not clear, the problem is probably in the wiring or network server. Contact your telephone service provider (charges may apply).
The Speed Dial key does not work at all.	<ul style="list-style-type: none">• The Speed Dial key may not be properly programmed.

QUESTION

SUGGESTIONS

I cannot dial out.

- Try all the above suggestions.
- A prefix may be required for dialing some internal or external calls
- Make sure there is a dial tone before dialing.
- Check your server settings. If other telephones in your hotel are having the same problem, the problem is in the wiring or network server. Contact your telephone service provider (charges may apply).

The telephone cannot register to the network server.

- Make sure your network is providing Power over Ethernet (PoE).
- Make sure the initialization and system registration process completes.
- If there is an error during the initialization and system registration process, the  key flashes twice every second. Disconnect the Cat-5 network cable from the network wall jack and connect it back into the network wall jack with Power over Ethernet (PoE) to start the initialization and system registration process again.

The telephone does not ring when there is an incoming call.

- Make sure the Cat-5 network cable is plugged into the LAN port of the telephone base and the network wall jack with Power over Ethernet (PoE).
- Check your server or telephone administrative settings.
- If other telephones in your hotel are having the same problem, the problem is in the wiring or network server. Contact your telephone service provider (charges may apply).
- Other electronic products such as HAM radios and other DECT telephones can cause interference with your cordless telephone. Try installing your telephone as far away as possible from these types of electronic devices.
- The Cat-5 network cable may be defective. Install a new Cat-5 network cable.

QUESTION**SUGGESTIONS**

I hear other calls when using the telephone.

- Disconnect the telephone base from the network wall jack and connect a different working telephone. Check your server settings. If calls are still not clear, the problem is probably in the wiring or network server. Contact your telephone service provider (charges may apply).
-

There is interference during a telephone conversation.

- If your telephone is plugged in with a modem or a surge protector, plug the telephone (or modem/surge protector) into a different location. If this doesn't solve the problem, relocate your telephone or modem farther apart from each other, or use a different surge protector.
 - Disconnect the telephone base from the telephone wall jack. Plug in a different telephone. If calls are still not clear, the problem is probably in the wiring or telephone service. Contact your telephone service provider (charges may apply).
 - If other telephones in your hotel are having the same problem, the problem is in the wiring or telephone service. Contact your telephone service provider (charges may apply).
-

Appendix

VTech Hospitality Limited Warranty Program

VTech Communications, Inc., the manufacturer of VTech Hospitality Product ("Product"), warrants to the holder of a valid proof of purchase ("end user" or "you") that the Product and all accessories provided by VTech in the Product's package are free from defects in material and workmanship, pursuant to the following terms and conditions, when installed and used normally and in accordance with the Product's operating instructions. The limited warranty extends to the end user of this Product and applies only if such Product is purchased through a United States of America and/or Canadian distributor. The limited warranty period for this Product is determined based on the following:

5 YEARS – ANALOG MODELS

- All Classic Models – corded and cordless
- All Contemporary Models – corded and cordless
- All TrimStyle Models
- All Next Gen Models - corded and cordless

2 YEARS – SIP NON-DISPLAY MODELS

- All Classic Models – corded and cordless
- All Contemporary Models – corded and cordless
- All TrimStyle Models
- All Next Gen Models - corded and cordless

During the limited warranty period, VTech's authorized service representative will repair or replace, at VTech's option, without charge, a Product that is not free from defects in materials and workmanship. If VTech's authorized service representative repairs the Product, new or refurbished replacement parts may be used. If the Product is replaced, it may be replaced with a new or refurbished Product of the same or similar design. Repair or replacement

of Product, at VTech's option, is the exclusive remedy.

The limited warranty period for the Product begins on the date that the end user takes possession of the Product. This limited warranty also applies to repaired or replacement Products for a period of either: (a) 90 days from the date the repaired or replacement Product is shipped to you; or (b) the time remaining on the original limited warranty as described above; whichever is longer.

This limited warranty does not cover:

1. Product or parts that have been subjected to misuse, accident, shipping or other physical damage, improper installation, abnormal operation or handling, neglect, inundation, fire, water or other liquid intrusion; or
2. Product that has been damaged due to repair, alteration or modification by anyone other than an authorized service representative of VTech; or
3. Product to the extent that the problem experienced is caused by signal conditions, network reliability or cable or antenna systems; or
4. Product to the extent that the problem is caused by use with non-VTech accessories; or
5. Product whose warranty/quality stickers, product serial number plates or electronic serial numbers have been removed, altered or rendered illegible; or
6. Product purchased, used, serviced, or shipped for repair from outside the United States or Canada, or used for non-approved commercial or institutional purposes (including but not limited to Products used for rental purposes); or
7. Product returned without valid proof of purchase; or
8. Charges or costs incurred by the end user, and risk of loss or damage, in removing and shipping the Product, or for installation or

set up, adjustment of customer controls, and installation or repair of systems outside the unit.

9. Line cords or coil cords, plastic overlays, connectors, power adapters and batteries, if the Product is returned without them. VTech will charge the end user at then-current prices for each of the missing items.
10. NiCd or NiMH handset batteries, or power adapters, which, under all circumstances, are covered by a one (1) year warranty only.

Except as provided by applicable law, you assume the risk of loss or damage during transit and transportation and are responsible for delivery or handling charges incurred in the transport of Product(s) to the service location. VTech's authorized service representative will return repaired or replaced product under this limited warranty to you, transportation, delivery and handling charges prepaid. VTech assumes no risk for damage or loss of the Product in transit.

If the Product failure is not covered by this limited warranty, or proof of purchase does not meet the terms of this limited warranty, VTech will notify you and will request that you authorize the cost of repair and return shipping costs for the repair of Products that not covered by this limited warranty. You must pay for the cost of repair and return shipping costs for the repair of Products that are not covered by this limited warranty.

OTHER LIMITATIONS

This warranty is the complete and exclusive agreement between you and VTech. It supersedes all other written or oral communications related to this Product. VTech provides no other warranties for this Product, whether express or implied, oral or written, or statutory. The warranty exclusively describes all of VTech's responsibilities regarding the Product. No one is authorized to make modifications to this warranty and you should not rely on any such modification.

VTech's liability to end user hereunder shall not exceed the purchase price of the Product. In no event shall VTech be liable for any indirect, special, incidental, consequential, or similar damages (including, but not limited to lost profits or revenue, inability to use the product, or other associated equipment, the cost of substitute equipment, and claims by third parties) resulting from the use of this Product. Some states/provinces do not allow the exclusion or limitation of incidental or consequential damages, so the above limitation or exclusion may not apply to you.

This warranty gives you specific legal rights, and you also have other rights which vary from state to state or province to province.

Appendix

FCC, ACTA and IC regulations

FCC PART 15

This device complies with Part 15 of the FCC rules. Operation is subject to the following two conditions:

- (1) This device may not cause harmful interference, and
- (2) this device must accept any interference received, including interference that may cause undesired operation.

This equipment has been tested and found to comply with the limits for a Class A digital device, pursuant to Part 15 of the FCC Rules. These limits are designed to provide reasonable protection against harmful interference when the equipment is operated in a commercial environment. This equipment generates, uses, and can radiate radio frequency energy and, if not installed and used in accordance with the instruction manual, may cause harmful interference to radio communications. Operation of this equipment in a residential area is likely to cause harmful interference in which case the user will be required to correct the interference at the user's expense.

WARNING: Changes or modifications to this equipment not expressly approved by the party responsible for compliance could void the user's authority to operate the equipment.

Privacy of communications may not be ensured when using this telephone.

RF Radiation Exposure

This VoIP Phone complies with FCC/ISED RF radiation exposure limits set forth for an uncontrolled environment.

Caution: To maintain compliance with the radio frequency exposure requirement, the phone shall be installed and used so that parts of user's body other than hands keep a distance of 20 cm or more.

FCC PART 68 AND ACTA

Consumer Information

- a. This equipment complies with Part 68 of the FCC rules and the requirements adopted by the Administrative Council for Terminal Attachments (ACTA). On the bottom of this equipment is a label that contains, among other information, a product identifier in the format US:AAAEQ##TXXXX. If requested, this number must be provided to the telephone company.
- b. An applicable certification jacks Universal Service Order Codes (USOC) for the equipment is provided (i.e., RJ45C) in the packaging with each piece of approved terminal equipment.
- c. A plug and jack used to connect this equipment to the premises wiring and telephone network must comply with the applicable FCC Part 68 rules and requirements adopted by the ACTA. A compliant LAN cable (RJ45) and modular plug is provided with this product. An RJ45 jack should normally be used for connecting to the SIP equipment through the LAN cable. See installation instructions for details.
- d. If this equipment causes harm to the telephone network, the telephone company will notify you in advance that temporary discontinuance of service may be required. But if advance notice isn't practical, the telephone company will notify the customer as soon as possible. Also, you will be advised of your right to file a complaint with the FCC if you believe it is necessary.
- e. The telephone company may make changes in its facilities, equipment, operations or procedures that could affect the operation of the equipment. If this happens the telephone company will provide advance notice in order for you to make necessary modifications to maintain uninterrupted service.
- f. Should you experience trouble with this

equipment, please contact
VTech Communications, Inc.
1-888-907-2007

for repair or warranty information. If the equipment is causing harm to the telephone network, the telephone company may request that you disconnect the equipment until the problem is resolved.

- g. Please follow instructions for repairing if any (e.g. battery replacement section); otherwise do not alternate or repair any parts of device except specified.
- h. Connection to party line service is subject to state tariffs. Contact the state public utility commission, public service commission or corporation commission for information.
- i. **NOTICE:** If your home has specially wired alarm equipment connected to the telephone line, ensure the installation of this SIP telephone does not disable your alarm equipment. If you have questions about what will disable alarm equipment, consult your telephone company or a qualified installer.
- j. This equipment is hearing aid compatible.

NOTICE: According to telephone company reports, AC electrical surges, typically resulting from lightning strikes, are very destructive to telephone equipment connected to AC power sources. To minimize damage from these types of surges, a surge arrester is recommended.

INDUSTRY CANADA

**This Class A digital apparatus complies with Canadian requirements:
CAN ICES-3 (A) / NMB-3(A).**

This device complies with Industry Canada licence-exempt RSS standard(s). Operation is subject to the following two conditions: (1) this device may not cause harmful interference, and (2) this device must accept any interference, including interference that may cause undesired operation of the device.

Privacy of communications may not be ensured when using this telephone.

The term "IC:" before the certification/ registration number only signifies that the Industry Canada technical specifications were met. This product meets the applicable Innovation, Science and Economic Development Canada technical specifications.

Operation of 5150-5350 MHz is restricted to indoor use only.

Appendix

Maintenance

TAKING CARE OF YOUR TELEPHONE

Your telephone contains sophisticated electronic parts, so it must be treated with care.

AVOID ROUGH TREATMENT

Place the handset down gently. Save the original packing materials to protect your telephone if you ever need to ship it.

AVOID WATER

Your telephone can be damaged if it gets wet. Do not use the handset outdoors in the rain, or handle it with wet hands. Do not install the telephone base near a sink, bathtub or shower.

ELECTRICAL STORMS

Electrical storms can sometimes cause power surges harmful to electronic equipment. For your own safety, take caution when using electrical appliances during storms.

CLEANING YOUR TELEPHONE

Your telephone has a durable plastic casing that should retain its luster for many years. Clean it only with a soft cloth slightly dampened with water or mild soap. Do not use excess water or cleaning solvents of any kind.

Disclaimer and Limitation of Liability

VTech Communications, Inc. and its suppliers assume no responsibility for any damage or loss resulting from the use of this user's manual. VTech Communications, Inc. and its suppliers assume no responsibility for any loss or claims by third parties that may arise through the use of this product. VTech Communications, Inc. and its suppliers assume no responsibility for any damage or loss caused by deletion of data as a result of malfunction, or repairs. Be sure to make backup copies of important data on other media to protect against data loss.

Company: VTech Communications, Inc.

Address: 9020 SW Washington Square Road., Suite 555, Tigard, OR 97223, United States

Phone: 1 (888) 907-2007

REMEMBER THAT ELECTRICAL APPLIANCES CAN CAUSE SERIOUS INJURY IF USED WHEN YOU ARE WET OR STANDING IN WATER. IF THE TELEPHONE BASE SHOULD FALL INTO WATER, DO NOT RETRIEVE IT UNTIL YOU UNPLUG THE POWER CORD AND/OR ETHERNET CABLE FROM THE WALL. THEN REMOVE THE TELEPHONE BY THE UNPLUGGED CORDS.

Technical specifications

SIP Next Gen Corded 1-line Hotel Telephone - NG-S3211

SIP Next Gen Corded 1-line Wi-Fi Enabled Hotel Telephone - NG-S3211W



Power requirement

PoE IEEE 802.3af class 2 (48V)

PoE IEEE 802.3af classe 2 (48V)

If PoE not available, power adapter (sold separately for NG-S3211 model):

- Input: 100-240V AC 50/60Hz Output: 5.0V DC @ 2.0A
- Manufacturer: VT-PLII
- Model identifier: VT07EUS05200
- Use only the power adapter indicated above for the telephone base

Message waiting signal

SIP messaging RFC 3261

Speed Dial memory

8 dedicated speed dial hard keys, with 2 additional hard keys (MESSAGE, EMERGENCY) that can be programmed as speed dial keys



Specifications are subject to change without notice.
Copyright © 2022
VTech Communications, Inc.
All rights reserved. 10/22.
NG-S3211_NG-S3211W_UG_V1_CEC_US_2022.10.06