

# flomtime

## D8-PD Bluetooth Speaker with Alarm Clock and Wireless Charging Function

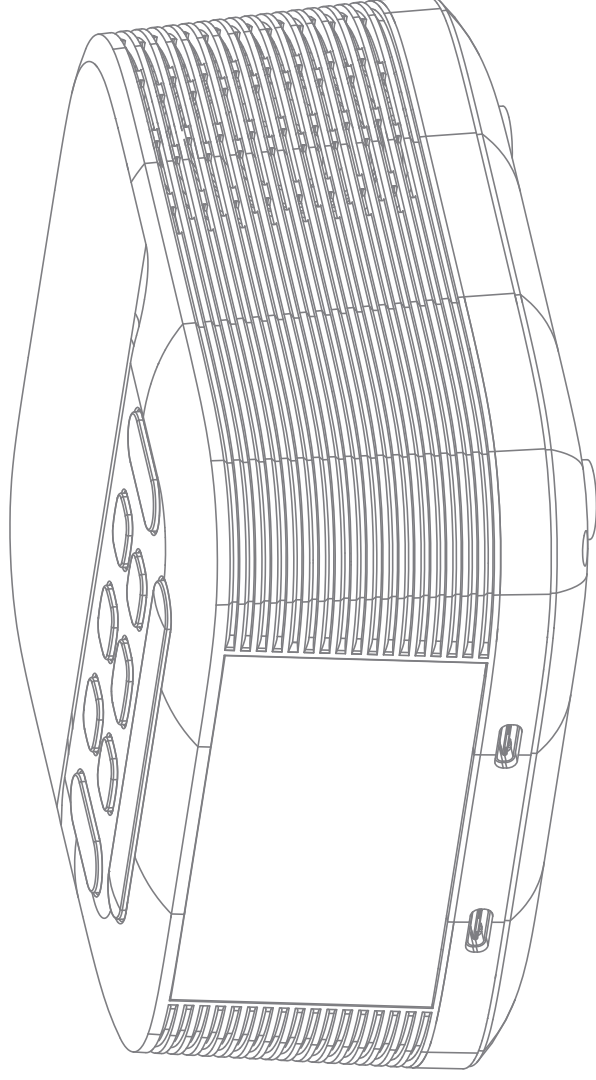

All safety and operation instructions should be read thoroughly before proceeding and please keep the handbook for future reference.

## INDEX



---

<b>CAUTION</b> .....	1	<b>CARE &amp; MAINTENANCE / FAQ</b> .....	9
<b>STEP TO BLUETOOTH FUNCTION</b> .....	2	<b>NOTICE</b> .....	10
<b>INFORMATION</b> .....	3		
Specifications .....	3		
What's in the box .....	3		
<b>UNIT FEATURES &amp; FUNCTIONS</b> .....	4		
<b>BASIC</b> .....	6		
Power On .....	6		
Setting The Time .....	6		
Setting The Daylight-saving Time .....	6		
Alarm Operation .....	6		
Fm Radio Operation .....	6		
Bluetooth Mode Operation .....	7		
Listening To Music .....	7		
Adjusting Display Brightness .....	8		
Usb Charging .....	8		
Backup Battery .....	8		
<b>WIRELESS CHARGING</b> .....	8		

---

## CAUTION



### KNOW THESE SAFETY SYMBOLS



This 'bolt of lightning' indicates uninsulated material within your unit may cause an electric shock. For the safety of everyone in your household, please do not remove product covering. The 'exclamation mark' calls attention to features for which you should read the enclosed literature closely to prevent operating and maintenance problems.

**WARNING:** To reduce the risk of fire or electric shock, this apparatus should not be exposed to rain or moisture and objects filled with liquids, such as vases, should not be placed on this apparatus.

**CAUTION:** To prevent electric shock, fully insert the plug. (For regions with polarized plugs: To prevent electric shock, match wide blade to wide slot.)

### IMPORTANT SAFETY INSTRUCTIONS

- a Read these instructions.
- b Keep these instructions.

- c Heed all warnings.
- d Follow all instructions.
- e Do not use this apparatus near water.
- f Clean only with dry cloth.
- g Do not block any ventilation openings. Install in accordance with the manufacturer's instructions.

h Do not install near any heat sources such as radiators, heat registers, stoves, or other apparatus (including amplifiers) that produce heat.

i Protect the power cord from being walked on or pinched, particularly at plugs, convenience receptacles, and the point where they exit from the apparatus.

j Only use attachments/accessories specified by the manufacturer.

k Unplug this apparatus during lightning storms or when unused for long periods of time.

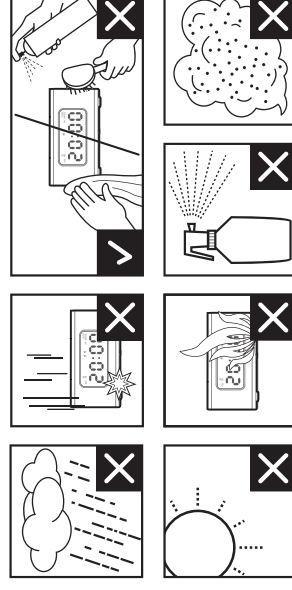

## STEP TO BLUETOOTH FUNCTION



### LISTEN

#### Pairing

First, register("pair") a Bluetooth device(mobile phone, etc) and this unit with each other. Once pairing is established, there is no need for pairing again

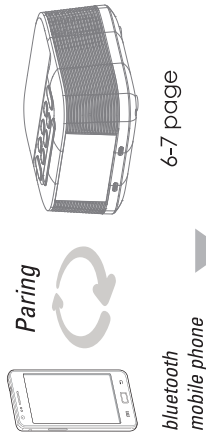

#### Bluetooth connection

Operate the Bluetooth device to make the Bluetooth connection.

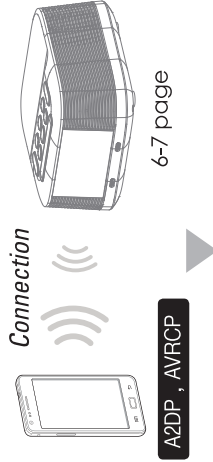

#### Listening to music

You can listen to music played on the Bluetooth device. Playback or pause is possible from this unit.

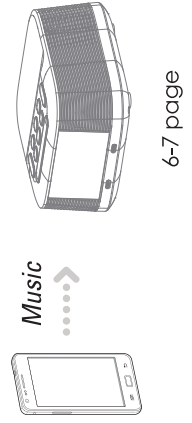

#### Pairing

First, register("pair") a Bluetooth device(mobile phone, etc) and this unit with each other. Once pairing is established, there is no need for pairing again

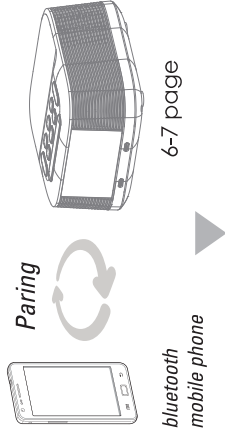

#### Bluetooth connection

When the unit is turned on, the unit starts making the Bluetooth connection to the recognized mobile phone automatically

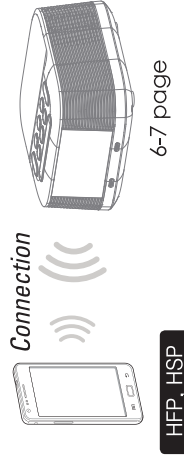

# INFORMATION



## SPECIFICATIONS

- Bluetooth Version: 5 .0
- Bluetooth Profiles: HSP, HFP, A2DP and AVRCP
- Bluetooth Distance: Within 10 meters
- Output Power: 3W+3W
- Power Adapter: DC 9V 2A
- Driver Unit: 4Ω 3W 2in
- Frequency Range: 40Hz-20KHz: 40Hz-20KHz
- S/N Ratio: >65dB
- Distortion Rate: <1%
- FM Frequency Response: 87.5 - 108MHz
- USB Charging Port Output: DC 5V 1A
- Wireless Charging Current: 5V 1A / 9V 1.1A
- Wireless Charger Output: 10W
- Wireless Distance: 6mm
- Wireless Charging Efficiency: 70%~80%
- Product Size: 138(L)×138(W) × 60(H)mm

*\* Product information is subject to change without prior notice.*

## WHAT'S IN THE BOX

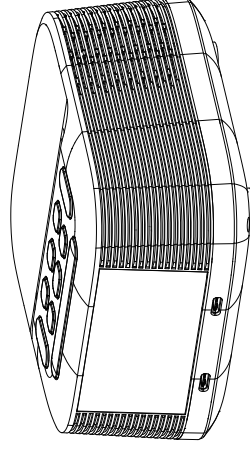

Unit

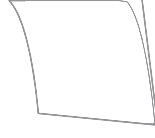

Manual

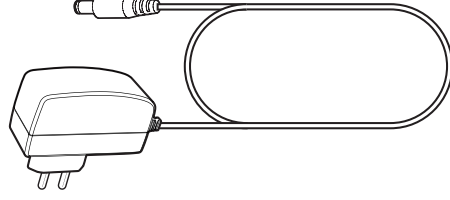

AC adapter

## UNIT FEATURES & FUNCTIONS

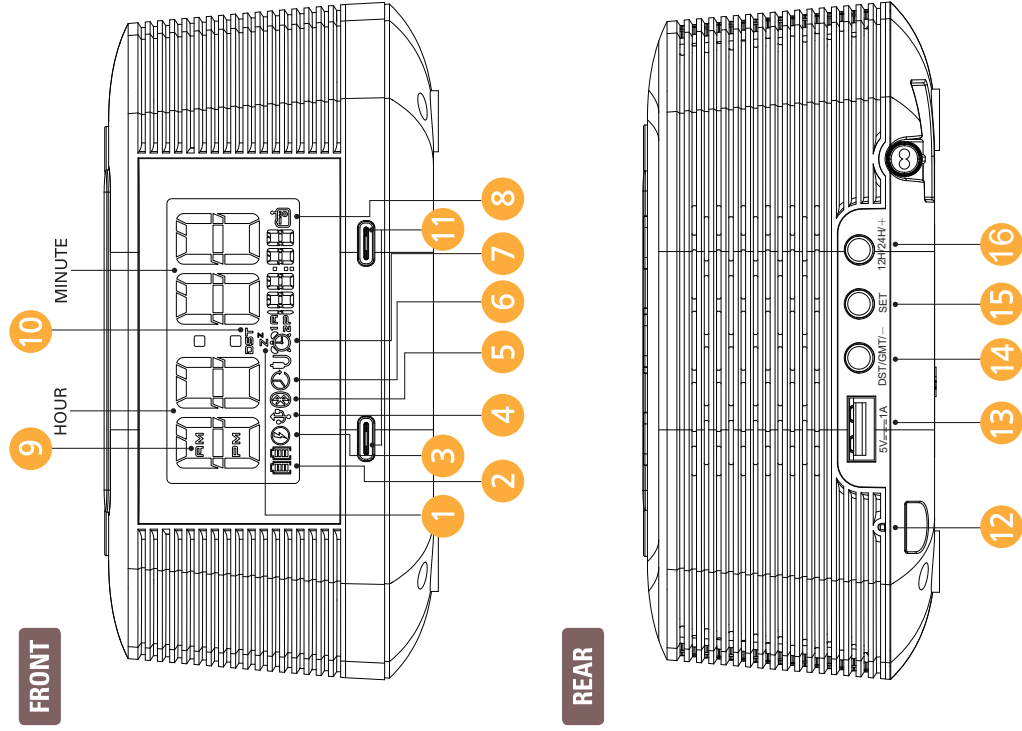

FUNCTION
1 SNOOZE
2 USB Charging Mode
3 Wireless Charging Mode
4 USB Charging Mode
5 Bluetooth Mode
6 SLEEP
7 Alarm Time
8 FM Mode
9 AM/PM Mode
10 Daylight-Saving Mode
11 TPYE-C Charging Mode
12 FM Antenna
13 USB Play/Charging Mode
14 Set clock & Daylight-Saving
15 Set clock time
16 Hour Mode Switch

## UNIT FEATURES & FUNCTIONS

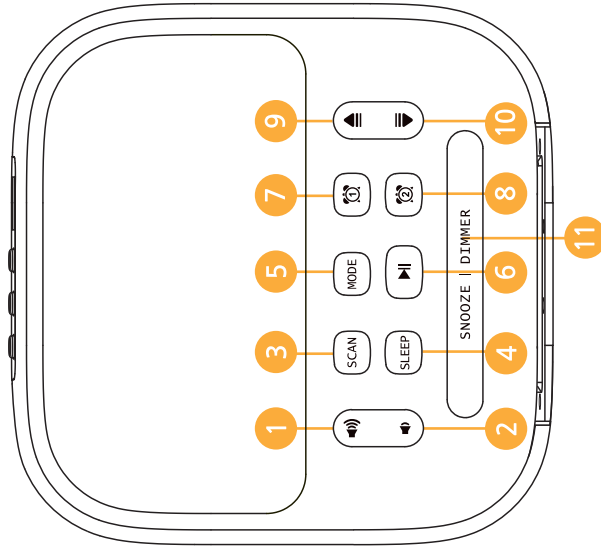

TOP

BUTTON	FUNCTION
1 VOL +	Volume up
2 VOL -	Volume down
3 FM	Auto scan FM station
4 SLEEP	SNOOZE 90-80-70-60-50-40-30-20-10-00 Minute
5 MODE	Switch modes among Bluetooth,FM ,USB Play and OFF
6 Bluetooth&USB mode	Bluetooth&USB mode: Play/Pause FM mode: Mute
7 Alarm 1	Turn on/off Alarm1 Set alarm clock and alarm ringtone
8 Alarm 2	Turn on/off Alarm2 Set alarm clock and alarm ringtone
9 BACKWARD SONG/Adjusting Alarm Time	Play music: Backward song Set alarm: Time+ FM mode: Short press to select the radio station; Long press for auto scanning
10 NEXT SONG/Adjusting Alarm Time	Play music: Next song Set alarm: Time- FM mode: Short press to select the radio station; Long press for auto scanning
11 SNOOZE/DIMMER	Adjust LCD brightness levels Short press to activate Snooze; Press and hold it for 3 seconds to turn off alarm

## POWER ON

Connect the power cable into the jack on the bottom of the device labeled "DC 9V", and then plug the power cable into the socket. The LCD display will show "0:00".

## SETTING THE TIME

- Under any mode, press on the rear of the unit.
- The hour digit and minute digit will flash. Press / to set the hour and press to confirm.
- Press / to set the minute and press to confirm the setting. (It exits the setting in 5 seconds if no operation on any key.)
- Press to select the 12H or 24H mode when time setting is done.

## SETTING THE DAYLIGHT-SAVING TIME

- Press on the rear of the unit to display the daylight-saving time. The "DST" symbol will display on the LCD display. To display the standard time, Short press then the "DST" symbol will disappear from the LCD display.

## ALARM OPERATION

Before setting the alarm time, make sure Clock has been set.

### Setting the alarm 1

Press on the top of the unit to turn on the alarm 1. The alarm 1 symbol will flash on the display. Press or on the top of the unit to select an alarm sound source: BU and RAD, and press to confirm. The hour digit will flash on the display. Press or to set the hour. Press to confirm. The minute digit will flash on the display, short press or to set the minute, then short press to confirm the alarm 1 setting.

It confirms the setting and exits automatically in 3 seconds if no operation on any key.

Note: If the RAD alarm sound source is selected for the alarm, please store the FM radio station firstly. The last stored FM radio station will be the default alarm sound source. When catching your favorite station, press on the top of the unit to stop the auto scanning, then your favorite radio station is the default alarm sound source.

- Setting the alarm 2 is same as setting the alarm 1. The alarm 1 is one-off alarm. The alarm 2 works everyday.

### Activating and deactivating the alarm

- If the alarm is activated, the display will show the symbol and/or the symbol. To deactivate the alarm:
  - Press or on the top of the unit, the alarm symbol will disappear from the display.



### Stop the alarm

When the alarm sounds, the alarm will gradually increase in volume for a more pleasant awakening.

- Press or press and hold SNOOZE for 3 seconds to turn off the alarm 1. The alarm will last for 30 minutes if no button is pressed. The alarm 1 will not work in the next day when it is deactivated.
- Press Alarm 2 or press and hold SNOOZE for 3 seconds to turn off the alarm 2. The alarm will last for 30 minutes if no button is pressed. The alarm 2 will work again in the next day.





## Snooze Function

Press SNOOZE to stop the alarm temporarily for about 9 minutes once the alarm is activated. The snooze function symbol will appear on the display. The alarm sounds will stop and sound again after about 9 minutes. Press  /  to turn off the alarm.

## FM RADIO OPERATION

Fully extend and reposition the wire aerial at the rear of the unit for optimum reception.

### Auto scan and save preset stations

- Repeatedly press  to select the radio mode. The radio symbol and frequency will be shown on the display.
- Press  to start auto scanning.

## BLUETOOTH MODE OPERATION

### Pairing with a Bluetooth-enabled device

- Press  on the top of the unit to select the Bluetooth mode. The Bluetooth symbol will flash on the display, indicating that the unit is trying to pair with a Bluetooth enabled device.
- Go to the Bluetooth setting on your Bluetooth enabled device. Search and connect to "D8qj". The Bluetooth symbol will stop flashing when your Bluetooth device has been paired successfully. An audible alert "Du" will sound.







- Bluetooth will be disconnected when the mode is switched or the unit is off.
- Once the Bluetooth device is connected for the first time, the unit will remember the paired setting and will automatically reconnect to the same Bluetooth device the next time they are in range.
- If the unit can not pair with the Bluetooth device successfully within 3 minutes, you will hear a "DUDU" warning tone. The unit will turn off the Bluetooth mode automatically.

When the unit is successfully connected and no music plays from the Bluetooth device within 18 minutes, the unit will also turn off the Bluetooth mode automatically.

### Disconnecting with a Bluetooth-enabled device

- Bluetooth will be disconnected when the mode is switched or the unit is off.
- Press and hold  for 3 seconds to disconnect with the Bluetooth device

## LISTENING TO MUSIC

- Once the unit has been successfully paired to your device, you can listen to music.
- Adjust the volume on your device to the desired level.
  - Repeatedly press  or  on the top of the unit to adjust the volume of the unit.
  - Press  to pause, Press  to resume play.
  - Repeatedly press  or  to select the previous or next song.
  - When you want to playback from another Bluetooth device, disconnect the speaker from the Bluetooth device already in use.

## WIRELESS CHARGE



### ADJUSTING DISPLAY BRIGHTNESS

Repeatedly press  to select the desired level of display brightness (High-Medium-Low-Off).

### USB CHARGING

- To charge your USB-compatible devices, plug them in the USB port on the rear of the unit and turn the unit on.
- The charging symbol will light up to indicate charging. The symbol will disappear from the display when the device is fully charged.

### BACKUP BATTERY

The battery used for the unit is one CR2032 battery(included). You can only use AC power as power supply. The battery is only for backup purpose.

If the system is unplugged or if a power failure occurs, the clock and alarm time settings of the unit will be erased unless there is a battery in the unit.

### WIRELESS CHARGING

Put the Qi receiver-enabled device on the top of the unit, where the Qi logo is printed. During wireless charging, the symbol will be on the display. It will disappear from the display when the device is fully charged. The symbol begins to flash quickly when abnormal charging happens.

### IMPORTANT NOTES ABOUT WIRELESS CHARGING

- a. If your device does not support wireless charging, please purchase a wireless charging case separately.
- b. Use only the approved power supply, otherwise, it will cause danger.
- c. Do not put a wireless charging case on the unit separately, which may cause the charging surface too hot and then cause fire disaster. It may cause serious burns or device failure.
- d. To charge a device without wireless charging function, please put on a wireless charger case for your device, then put it on the unit for wireless charging.
- e. Do not put any foreign objects including metal, magnetic absorbers and IC cards in the charging defective area, which may cause abnormal charging or damage the unit because of too much heat.
- f. Please take always the device from the charging area when the device is fully charged.
- g. Please place the device on the charging area correctly to make sure the wireless charging works properly.
- h. Over 6mm thickness phone case may result in charging intermittently or discontinued. Please take off the phone case before charging.
- j. During wireless charging, if connecting power supply to the phone device, it will stop the wireless charging.

### CARE AND MAINTENANCE

Read the following recommendations before using the unit. Following these you will be able to enjoy our product for many years.

1. *Keep the product dry and don't put it in the damp place to avoid the product's internal circuit being affected.*
2. *Keep the product away from direct sunlight or hot places. High temperature will shorten the life of electronic devices, destroy the battery or distort certain plastic parts.*
3. *Don't expose the product to cold areas as it may damage the internal circuit board.*
4. *Don't try to disassemble the product as it may get damaged if you are not professional.*
5. *Don't let the product fall down onto the floor or other hard surfaces. The internal circuit might get damaged.*
6. *Don't use intensive chemical products or detergent to clean the product.*
7. *Don't scratch the surface with sharp things.*

### FAQs

*What to do when my mobile phone can not search and find the unit ?*

*If the unit is not in pairing mode, your mobile phone can't find it. Please make sure **the unit** is in pairing mode and in the effective working range.*

*How far is the effective range between the unit and Bluetooth mobile phone?*

*According to the Bluetooth standard, the max. controllable range of Class II handsfree kit is 10 meters. But it varies with different environment and paired mobile phone.*

*Poor radio reception?*

1. *Keep the clock radio away from other electronic devices to avoid radio interference.*
2. *Fully extend and adjust the position of the FM antenna.*

*No response from the clock radio*

*Disconnect and reconnect the power cavlllllllllll, then turn on the clock radio again.*

## NOTICE

### *Clock/alarm setting erased*

1. Power has been interrupted or the power plug has been disconnected.
2. Reset the clock/alarm.
3. Back up battery was dead, so please change it.

*When you use the USB power supply cable, it can occur that a charging delay and being not charged phenomenon. To charge battery effectively, please use the AC adapter. (\*extra buying)*

## NOTICE



*Your product is designed and manufactured with high quality materials and components, which can be recycled and reused.*



*When this crossed-out wheeled bin symbol is attached to a product it means that the product is covered by the European Directive 2002/96/EC. Please inform yourself about the local separate collection system for electrical and electronic products. Please act according to your local rules and do not dispose*

*of your old products with your normal household waste. Correct disposal of your old product helps to prevent potential negative consequences for the environment and human health.*



*Your product contains batteries covered by the European Directive 2006/66/EC, which cannot be disposed with normal household waste. Please inform yourself about the local rules on separate collection of batteries because correct disposal helps to prevent negative consequences for the environmental and human health.*

*\* Please comply with the actual product if there is any discrepancy between the product and the content of the manual*

## FCC Caution.

This device complies with part 15 of the FCC Rules. Operation is subject to the following two conditions: (1) This device may not cause harmful interference, and (2) this device must accept any interference received, including interference that may cause undesired operation. Any Changes or modifications not expressly approved by the party responsible for compliance could void the user's authority to operate the equipment.

### Note:

This equipment has been tested and found to comply with the limits for a Class B digital device, pursuant to part 15 of the FCC Rules. These limits are designed to provide reasonable protection against harmful interference in a residential installation. This equipment generates uses and can radiate radio frequency energy and, if not installed and used in accordance with the instructions, may cause harmful interference to radio communications. However, there is no guarantee that interference will not occur in a particular installation. If this equipment does cause harmful interference to radio or television reception, which can be determined by turning the equipment off and on, the user is encouraged to try to correct the interference by one or more of the following measures:

- Reorient or relocate the receiving antenna.
- Increase the separation between the equipment and receiver.
- Connect the equipment into an outlet on a circuit different from that to which the receiver is connected.
- Consult the dealer or an experienced radio/TV technician for help.

### RF warning for Portable device:

The device has been evaluated to meet general RF exposure requirement. The device can be used in portable exposure condition without restriction.

### RF warning for WPT device:

The equipment complies with FCC radiation exposure limits set forth for an uncontrolled environment. During the operation of device a distance of 15cm surrounding the device and 20 cm above the top surface of the device must be respected.